

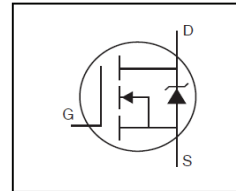
**Features**

- Advanced Planar Technology
- Low On-Resistance
- Logic Level Gate Drive
- Dynamic dv/dt Rating
- 150°C Operating Temperature
- Fast Switching
- Fully Avalanche Rated
- Repetitive Avalanche Allowed up to Tjmax
- Lead-Free, RoHS Compliant
- Automotive Qualified \*

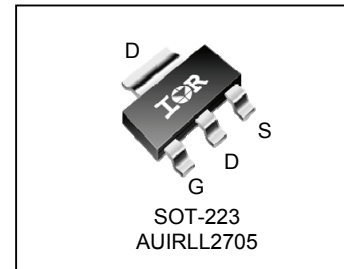
**Description**

Specifically designed for Automotive applications, this cellular design of HEXFET® Power MOSFETs utilizes the latest processing techniques to achieve low on-resistance per silicon area. This benefit combined with the fast switching speed and ruggedized device design that HEXFET power MOSFETs are well known for, provides the designer with an extremely efficient and reliable device for use in Automotive and a wide variety of other applications.

HEXFET® Power MOSFET



|                   |              |
|-------------------|--------------|
| $V_{DSS}$         | <b>55V</b>   |
| $R_{DS(on)}$ max. | <b>0.04Ω</b> |
| $I_D$             | <b>3.8A</b>  |



|          |          |          |
|----------|----------|----------|
| <b>G</b> | <b>D</b> | <b>S</b> |
| Gate     | Drain    | Source   |

| Base part number | Package Type | Standard Pack |          | Orderable Part Number |
|------------------|--------------|---------------|----------|-----------------------|
|                  |              | Form          | Quantity |                       |
| AUIRLL2705       | SOT-223      | Tape and Reel | 2500     | AUIRLL2705TR          |

**Absolute Maximum Ratings**

Stresses beyond those listed under “Absolute Maximum Ratings” may cause permanent damage to the device. These are stress ratings only; and functional operation of the device at these or any other condition beyond those indicated in the specifications is not implied. Exposure to absolute-maximum-rated conditions for extended periods may affect device reliability. The thermal resistance and power dissipation ratings are measured under board mounted and still air conditions. Ambient temperature (TA) is 25°C, unless otherwise specified.

| Symbol                   | Parameter   | Max.         | Units |
|--------------------------|---|--------------|-------|
| $I_D @ T_A = 25^\circ C$ | Continuous Drain Current, $V_{GS} @ 10V$ ⑥          | 5.2          | A     |
| $I_D @ T_A = 25^\circ C$ | Continuous Drain Current, $V_{GS} @ 10V$ ⑤          | 3.8          |       |
| $I_D @ T_A = 70^\circ C$ | Continuous Drain Current, $V_{GS} @ 10V$ ⑤          | 3.0          |       |
| $I_{DM}$                 | Pulsed Drain Current ①                              | 30           |       |
| $P_D @ T_A = 25^\circ C$ | Maximum Power Dissipation (PCB Mount) ⑥             | 2.1          | W     |
| $P_D @ T_A = 25^\circ C$ | Maximum Power Dissipation (PCB Mount) ⑤             | 1.0          |       |
|                          | Linear Derating Factor (PCB Mount) ⑤                | 8.3          | mW/°C |
| $V_{GS}$                 | Gate-to-Source Voltage                              | ± 16         | V     |
| $E_{AS}$                 | Single Pulse Avalanche Energy (Thermally Limited) ② | 110          | mJ    |
| $I_{AR}$                 | Avalanche Current ①                                 | 3.8          | A     |
| $E_{AR}$                 | Repetitive Avalanche Energy ① ⑤                     | 0.10         | mJ    |
| dv/dt                    | Peak Diode Recovery dv/dt ③                         | 7.5          | V/ns  |
| $T_J$                    | Operating Junction and                              | -55 to + 150 | °C    |
| $T_{STG}$                | Storage Temperature Range                           |              |       |

**Thermal Resistance**

| Symbol          | Parameter                                       | Typ. | Max. | Units |
|-----------------|---|------|------|-------|
| $R_{\theta JA}$ | Junction-to-Ambient (PCB Mount, steady state) ⑥ | 93   | 120  | °C/W  |
| $R_{\theta JA}$ | Junction-to-Ambient (PCB Mount, steady state) ⑥ | 48   | 60   |       |

HEXFET® is a registered trademark of Infineon.

\*Qualification standards can be found at [www.infineon.com](http://www.infineon.com)

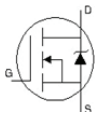
**Static @ T<sub>J</sub> = 25°C (unless otherwise specified)**

|  | Parameter                            | Min. | Typ.  | Max.  | Units | Conditions  |
|--|--------------------------------------|------|-------|-------|-------|---|
| V <sub>(BR)DSS</sub>                   | Drain-to-Source Breakdown Voltage    | 55   | —     | —     | V     | V <sub>GS</sub> = 0V, I <sub>D</sub> = 250μA                        |
| ΔV <sub>(BR)DSS</sub> /ΔT <sub>J</sub> | Breakdown Voltage Temp. Coefficient  | —    | 0.061 | —     | V/°C  | Reference to 25°C, I <sub>D</sub> = 1mA                             |
| R <sub>DS(on)</sub>                    | Static Drain-to-Source On-Resistance | —    | —     | 0.040 | Ω     | V <sub>GS</sub> = 10V, I <sub>D</sub> = 3.8A ④                      |
|  |                                      | —    | —     | 0.051 |       | V <sub>GS</sub> = 5.0V, I <sub>D</sub> = 3.8A ④                     |
|  |                                      | —    | —     | 0.065 |       | V <sub>GS</sub> = 4.0V, I <sub>D</sub> = 1.9A ④                     |
| V <sub>GS(th)</sub>                    | Gate Threshold Voltage               | 1.0  | —     | 2.0   | V     | V <sub>DS</sub> = V <sub>GS</sub> , I <sub>D</sub> = 250μA          |
| g <sub>fs</sub>                        | Forward Trans conductance            | 5.1  | —     | —     | S     | V <sub>DS</sub> = 25V, I <sub>D</sub> = 1.9A                        |
| I <sub>DSS</sub>                       | Drain-to-Source Leakage Current      | —    | —     | 25    | μA    | V <sub>DS</sub> = 55V, V <sub>GS</sub> = 0V                         |
|  |                                      | —    | —     | 250   |       | V <sub>DS</sub> = 44V, V <sub>GS</sub> = 0V, T <sub>J</sub> = 150°C |
| I <sub>GSS</sub>                       | Gate-to-Source Forward Leakage       | —    | —     | 100   | nA    | V <sub>GS</sub> = 16V   |
|  | Gate-to-Source Reverse Leakage       | —    | —     | -100  |       | V <sub>GS</sub> = -16V  |

**Dynamic Electrical Characteristics @ T<sub>J</sub> = 25°C (unless otherwise specified)**

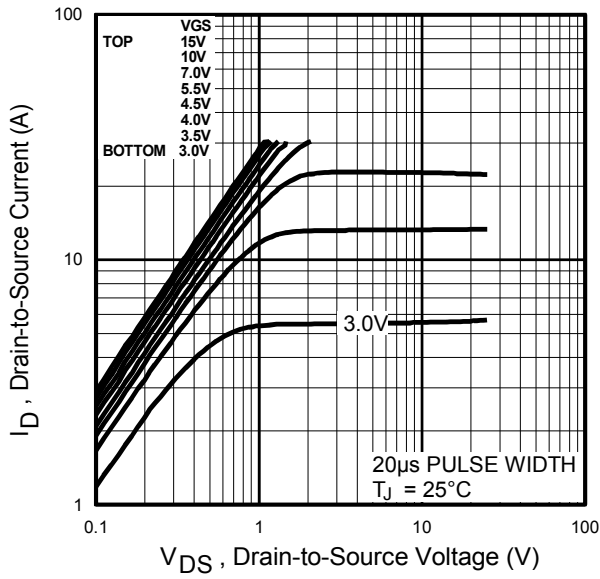
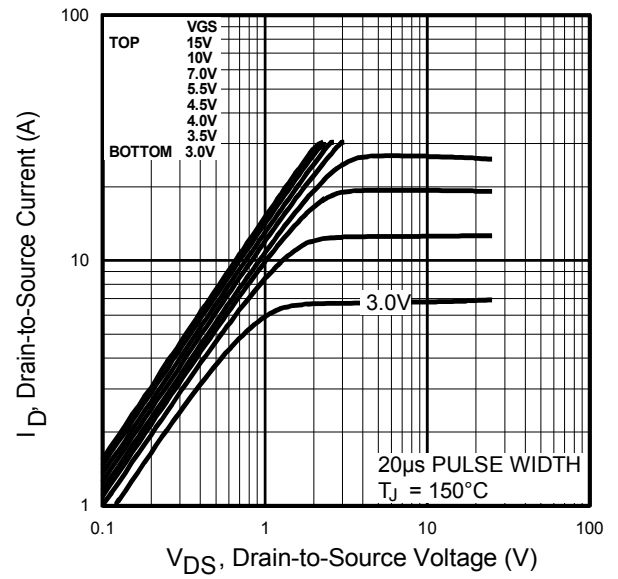
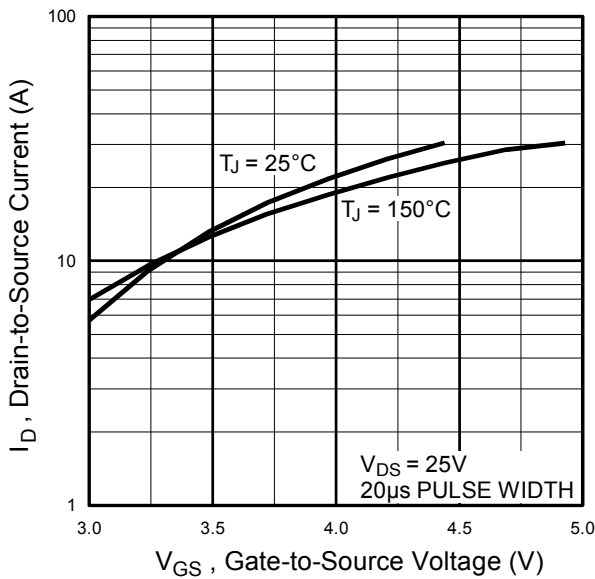
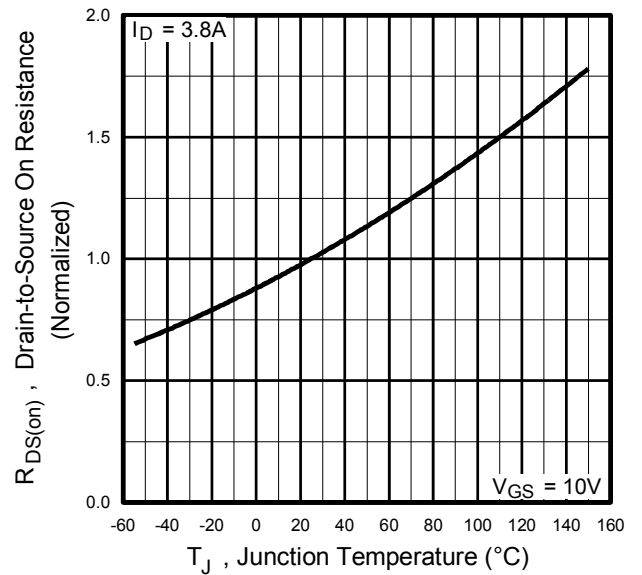
|                     |                              |   |     |     |    |  |
|---------------------|------------------------------|---|-----|-----|----|--|
| Q <sub>g</sub>      | Total Gate Charge            | — | 32  | 48  | nC | I <sub>D</sub> = 3.8A                    |
| Q <sub>gs</sub>     | Gate-to-Source Charge        | — | 3.5 | 5.3 |    | V <sub>DS</sub> = 44V                    |
| Q <sub>gd</sub>     | Gate-to-Drain Charge         | — | 9.7 | 14  |    | V <sub>GS</sub> = 10V, See Fig 6 and 9 ④ |
| t <sub>d(on)</sub>  | Turn-On Delay Time           | — | 6.2 | —   | ns | V <sub>DD</sub> = 28V                    |
| t <sub>r</sub>      | Rise Time                    | — | 12  | —   |    | I <sub>D</sub> = 3.8A                    |
| t <sub>d(off)</sub> | Turn-Off Delay Time          | — | 35  | —   |    | R <sub>G</sub> = 6.2Ω                    |
| t <sub>f</sub>      | Fall Time                    | — | 22  | —   |    | R <sub>D</sub> = 7.1Ω, See Fig. 10 ④     |
| C <sub>iss</sub>    | Input Capacitance            | — | 870 | —   | pF | V <sub>GS</sub> = 0V                     |
| C <sub>oss</sub>    | Output Capacitance           | — | 220 | —   |    | V <sub>DS</sub> = 25V                    |
| C <sub>rss</sub>    | Reverse Transfer Capacitance | — | 92  | —   |    | f = 1.0MHz, See Fig.5                    |

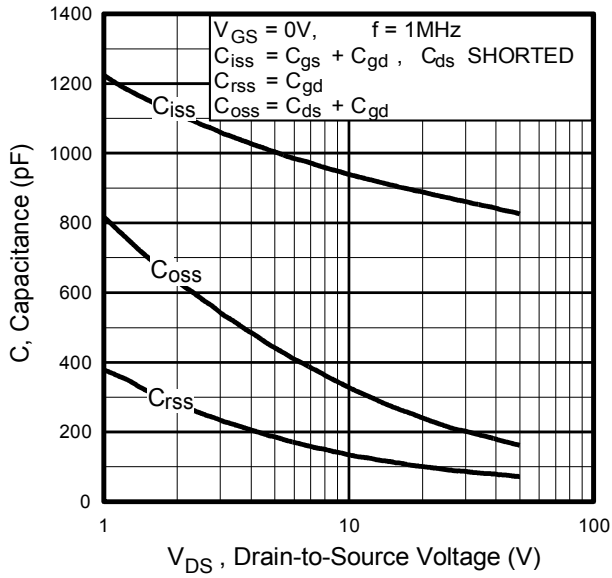
**Diode Characteristics**

|                 | Parameter                              | Min.   | Typ. | Max. | Units | Conditions   |
|-----------------|--|--|------|------|-------|--|
| I <sub>S</sub>  | Continuous Source Current (Body Diode) | —  | —    | 0.91 | A     | MOSFET symbol showing the integral reverse p-n junction diode.  |
| I <sub>SM</sub> | Pulsed Source Current (Body Diode) ①   | —  | —    | 30   |       |  |
| V <sub>SD</sub> | Diode Forward Voltage                  | —  | —    | 1.3  | V     | T <sub>J</sub> = 25°C, I <sub>S</sub> = 3.8A, V <sub>GS</sub> = 0V ④   |
| t <sub>rr</sub> | Reverse Recovery Time                  | —  | 58   | 88   | ns    | T <sub>J</sub> = 25°C, I <sub>F</sub> = 3.8A   |
| Q <sub>rr</sub> | Reverse Recovery Charge                | —  | 140  | 210  | nC    | di/dt = 100A/μs ④  |
| t <sub>on</sub> | Forward Turn-On Time                   | Intrinsic turn-on time is negligible (turn-on is dominated by LS+LD) |      |      |       |  |

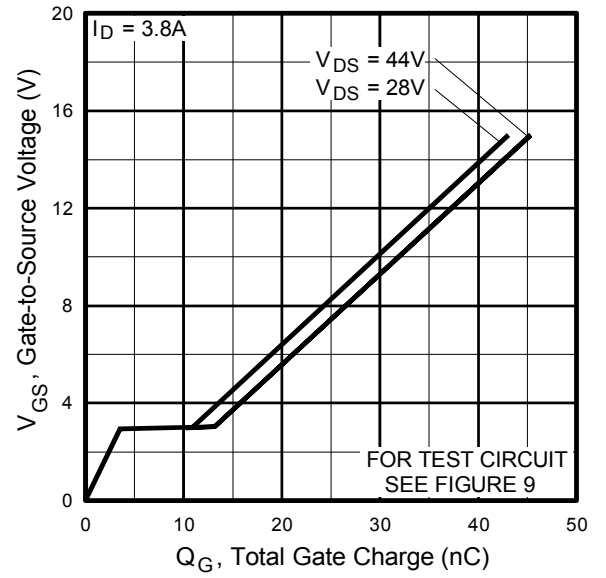
**Notes:**

- ① Repetitive rating; pulse width limited by max. junction temperature. (See fig. 11)
- ② V<sub>DD</sub> = 25V, Starting T<sub>J</sub> = 25°C, L = 15mH, R<sub>G</sub> = 25Ω, I<sub>AS</sub> = 3.8A. (See fig. 12)
- ③ I<sub>SD</sub> ≤ 3.8A, di/dt ≤ 220A/μs, V<sub>DD</sub> ≤ V<sub>(BR)DSS</sub>, T<sub>J</sub> ≤ 150°C.
- ④ Pulse width ≤ 300μs; duty cycle ≤ 2%.
- ⑤ When mounted on FR-4 board using minimum recommended footprint.
- ⑥ When mounted on 1 inch square copper board, for comparison with other SMD devices.

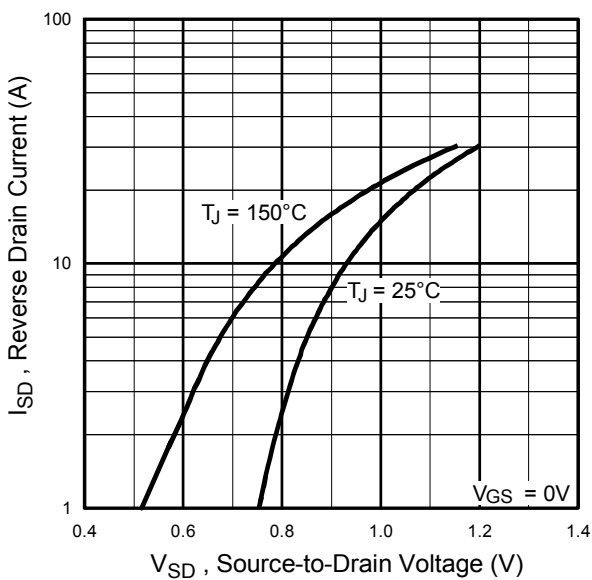

**Fig. 1** Typical Output Characteristics

**Fig. 2** Typical Output Characteristics

**Fig. 3** Typical Transfer Characteristics

**Fig. 4** Normalized On-Resistance vs. Temperature



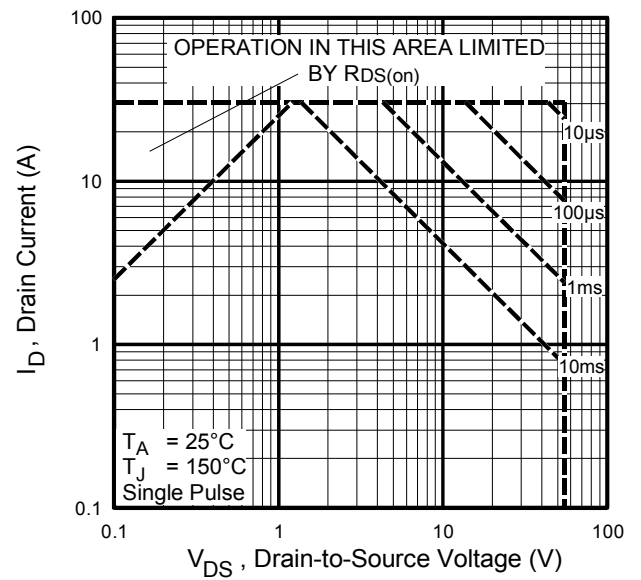
**Fig 5.** Typical Capacitance vs. Drain-to-Source Voltage



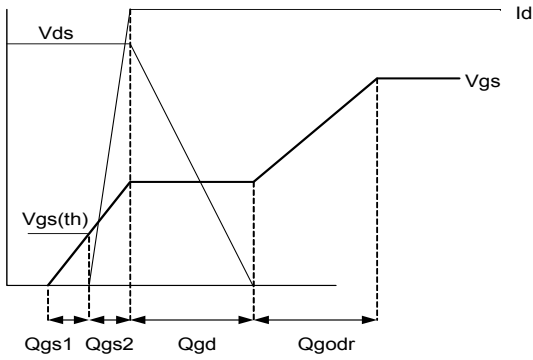
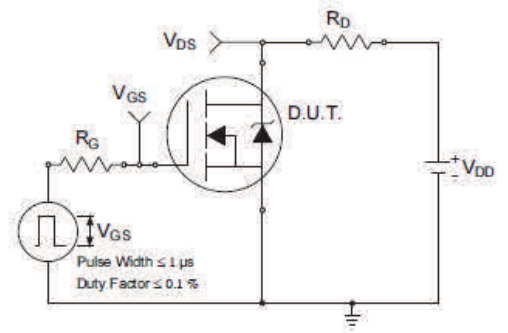
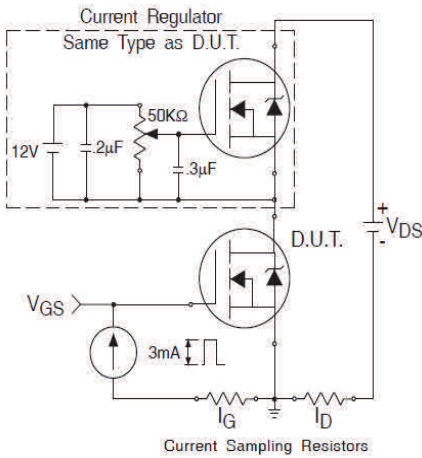
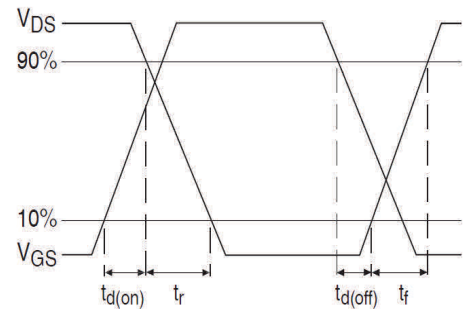
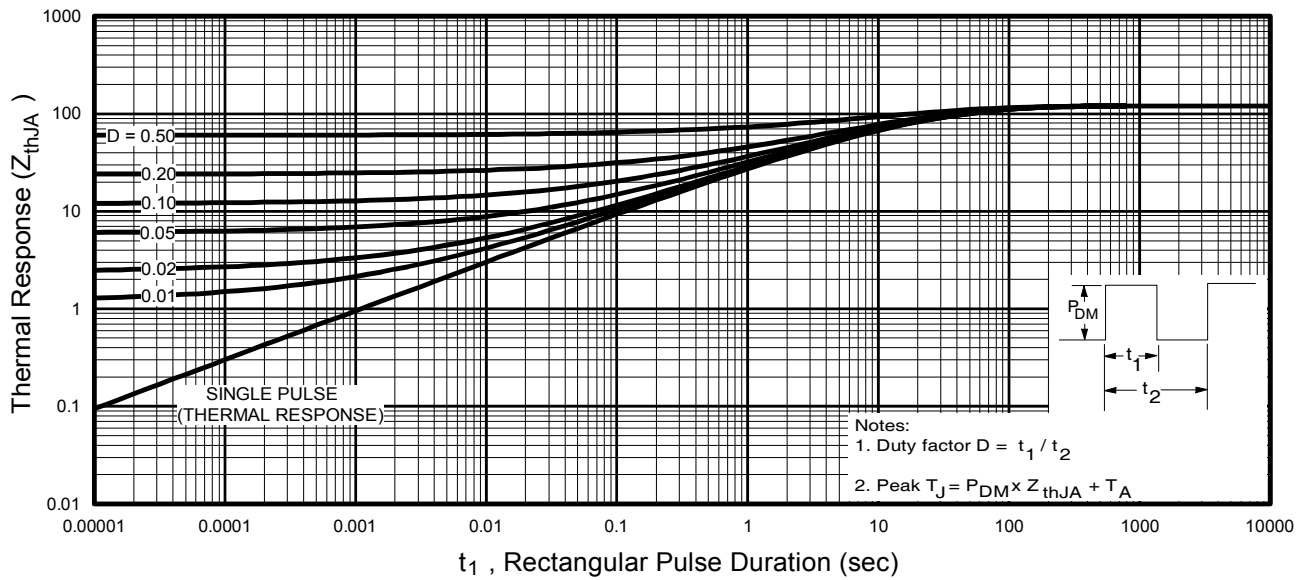
**Fig 6.** Typical Gate Charge vs. Gate-to-Source Voltage

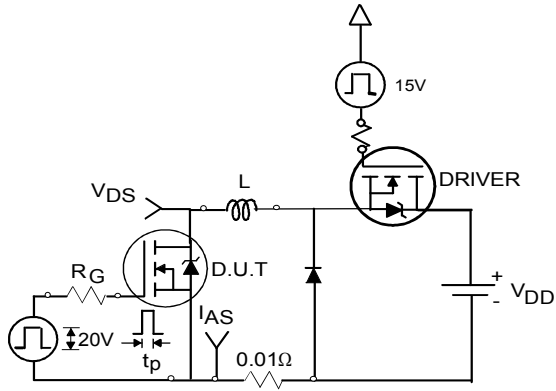
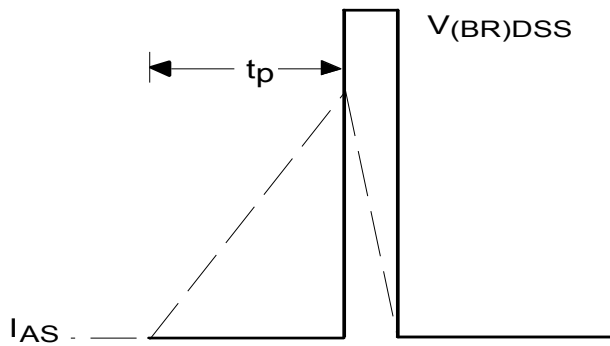
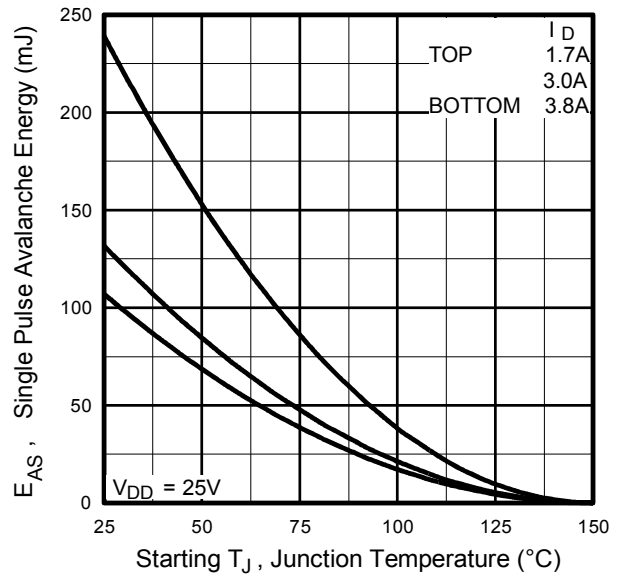


**Fig. 7** Typical Source-to-Drain Diode Forward Voltage

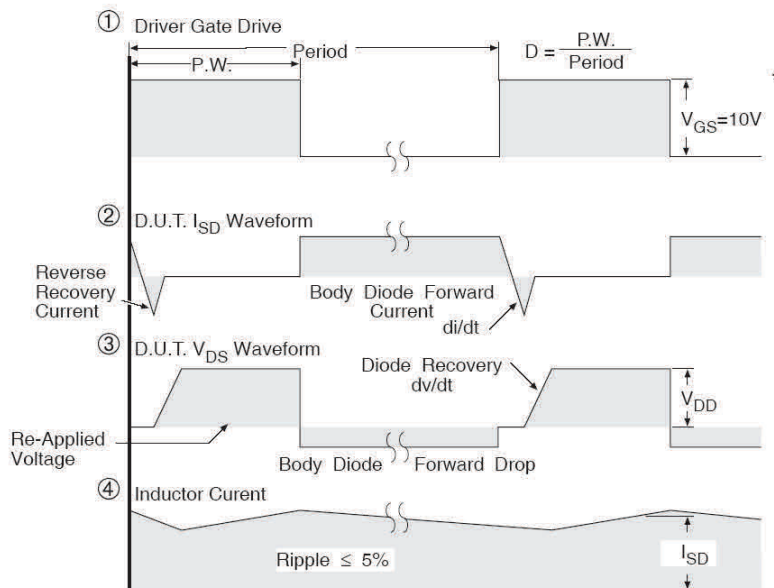
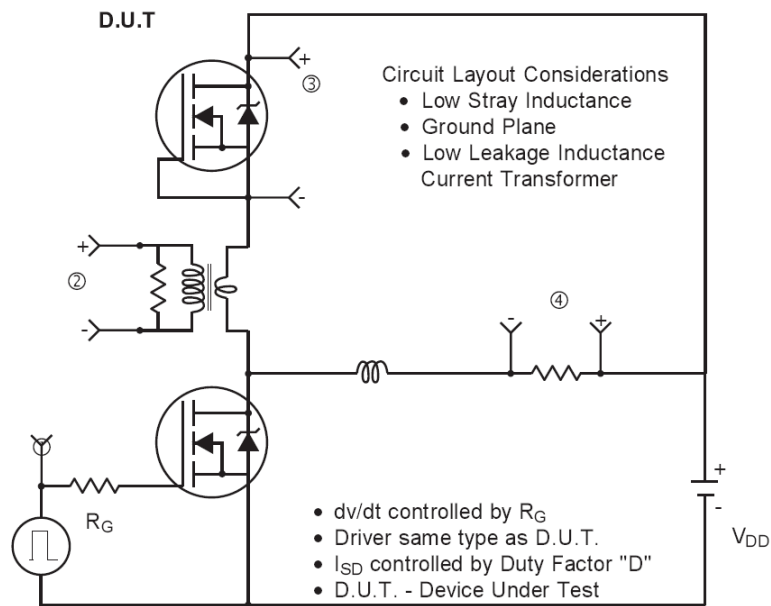


**Fig 8.** Maximum Safe Operating Area


**Fig 9a. Basic Gate Charge Waveform**

**Fig 10a. Switching Time Test Circuit**

**Fig 9b. Gate Charge Test Circuit**

**Fig 10b. Switching Time Waveforms**

**Fig 11. Maximum Effective Transient Thermal Impedance, Junction-to-Ambient**


**Fig 12a.** Unclamped Inductive Test Circuit

**Fig 12b.** Unclamped Inductive Waveforms

**Fig 12c.** Maximum Avalanche Energy Vs. Drain Current

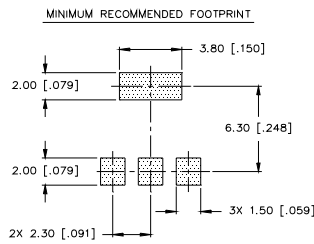
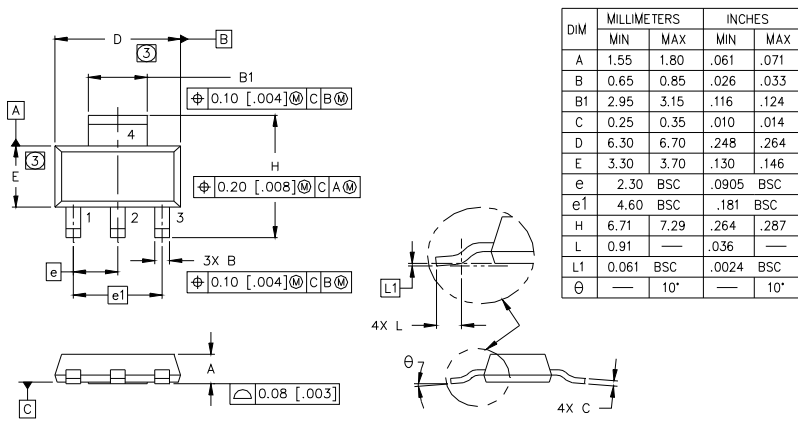
### Peak Diode Recovery dv/dt Test Circuit



\*  $V_{GS} = 5V$  for Logic Level Devices

**Fig 13.** Peak Diode Recovery  $dv/dt$  Test Circuit for N-Channel HEXFET® Power MOSFETs

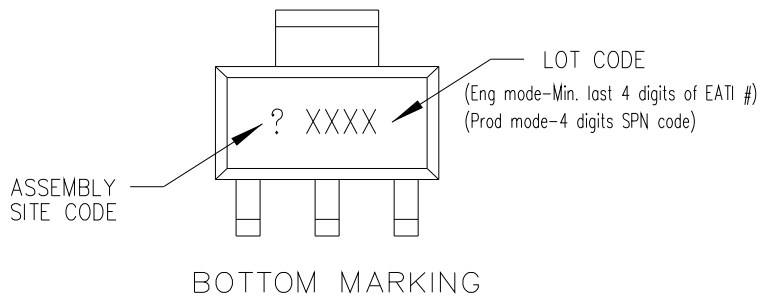
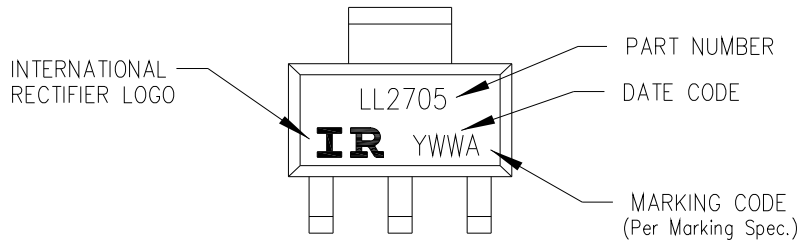
# SOT-223 (TO-261AA) Package Outline (Dimensions are shown in millimeters (inches))



- LEAD ASSIGNMENTS**
- 1 = GATE
  - 2 = DRAIN
  - 3 = SOURCE
  - 4 = DRAIN

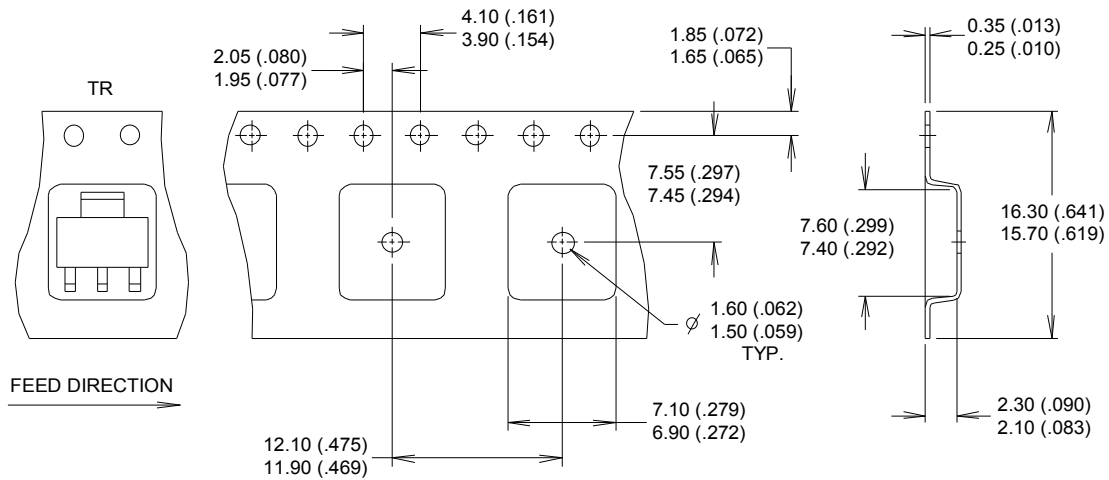
- NOTES:**
1. DIMENSIONING & TOLERANCING PER ASME Y14.5M-1994.
  2. CONTROLLING DIMENSION: INCH.
  3. DIMENSIONS DO NOT INCLUDE MOLD FLASH.
  4. OUTLINE CONFORMS TO JEDEC OUTLINE TO-261AA.
  5. DIMENSIONS ARE SHOWN IN MILLIMETERS [INCHES].

## SOT-223(TO-261AA) Part Marking Information

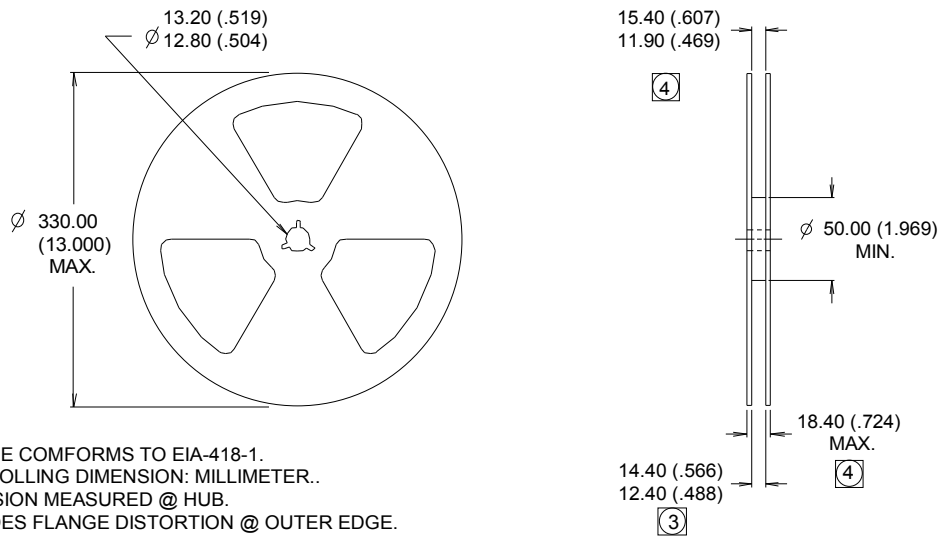


Note: For the most current drawing please refer to IR website at <http://www.irf.com/package/>



**SOT-223(TO-261AA) Tape and Reel** (Dimensions are shown in millimeters (inches))


- NOTES :
1. CONTROLLING DIMENSION: MILLIMETER.
  2. OUTLINE CONFORMS TO EIA-481 & EIA-541.
  3. EACH  $\varnothing 330.00$  (13.00) REEL CONTAINS 2,500 DEVICES.



- NOTES :
1. OUTLINE COMFORMS TO EIA-418-1.
  2. CONTROLLING DIMENSION: MILLIMETER..
  - ③ DIMENSION MEASURED @ HUB.
  - ④ INCLUDES FLANGE DISTORTION @ OUTER EDGE.

Note: For the most current drawing please refer to IR website at <http://www.irf.com/package/>

**Qualification Information**

|                                   |                      |   |      |
|-----------------------------------|----------------------|---|------|
| <b>Qualification Level</b>        |                      | Automotive<br>(per AEC-Q101)  |      |
|                                   |                      | Comments: This part number(s) passed Automotive qualification. Infineon's Industrial and Consumer qualification level is granted by extension of the higher Automotive level. |      |
| <b>Moisture Sensitivity Level</b> |                      | SOT-223   | MSL1 |
| <b>ESD</b>                        | Machine Model        | Class M2 (+/- 200V) <sup>†</sup><br>AEC-Q101-002  |      |
|                                   | Human Body Model     | Class H1B (+/- 750V) <sup>†</sup><br>AEC-Q101-001   |      |
|                                   | Charged Device Model | Class C5 (+/- 1125V) <sup>†</sup><br>AEC-Q101-005   |      |
| <b>RoHS Compliant</b>             |                      | Yes   |      |

† Highest passing voltage.

**Revision History**

| Date       | Comments   |
|------------|--|
| 3/26/2014  | <ul style="list-style-type: none"> <li>Added "Logic Level Gate Drive" bullet in the features section on page 1</li> <li>Updated part marking on page 8</li> <li>Updated data sheet with new IR corporate template</li> </ul> |
| 10/29/2015 | <ul style="list-style-type: none"> <li>Updated datasheet with corporate template</li> <li>Corrected ordering table on page 1.</li> </ul>   |

**Published by**

**Infineon Technologies AG**  
81726 München, Germany

© Infineon Technologies AG 2015

All Rights Reserved.

**IMPORTANT NOTICE**

The information given in this document shall in no event be regarded as a guarantee of conditions or characteristics ("Beschaffenheitsgarantie"). With respect to any examples, hints or any typical values stated herein and/or any information regarding the application of the product, Infineon Technologies hereby disclaims any and all warranties and liabilities of any kind, including without limitation warranties of non-infringement of intellectual property rights of any third party.

In addition, any information given in this document is subject to customer's compliance with its obligations stated in this document and any applicable legal requirements, norms and standards concerning customer's products and any use of the product of Infineon Technologies in customer's applications.

The data contained in this document is exclusively intended for technically trained staff. It is the responsibility of customer's technical departments to evaluate the suitability of the product for the intended application and the completeness of the product information given in this document with respect to such application.

For further information on the product, technology, delivery terms and conditions and prices please contact your nearest Infineon Technologies office ([www.infineon.com](http://www.infineon.com)).

**WARNINGS**

Due to technical requirements products may contain dangerous substances. For information on the types in question please contact your nearest Infineon Technologies office.

Except as otherwise explicitly approved by Infineon Technologies in a written document signed by authorized representatives of Infineon Technologies, Infineon Technologies' products may not be used in any applications where a failure of the product or any consequences of the use thereof can reasonably be expected to result in personal injury.