

# 16-Bit Mono Audio Voice Codec

## General Description

The MAX9860 is a low-power, voiceband, mono audio codec designed to provide a complete audio solution for wireless voice headsets and other mono voice audio devices. Using an on-chip bridge-tied load mono headphone amplifier, the MAX9860 can output 30mW into a 32Ω earpiece while operating from a single 1.8V power supply. Very low power consumption makes it an ideal choice for battery-powered applications.

The MAX9860's flexible clocking circuitry utilizes common system clock frequencies ranging from 10MHz to 60MHz, eliminating the need for an external PLL and multiple crystal oscillators. Both the ADC and DAC support sample rates of 8kHz to 48kHz in either synchronous or asynchronous operation. Both master and slave timing modes are supported.

Two differential microphone inputs are available with a user-programmable preamplifier and programmable gain amplifier. Automatic gain control with selectable attack/release times and signal threshold allows maximum dynamic range. A noise gate with selectable threshold provides a means to quiet the channel when no signal is present. Both the DAC and ADC digital filters provide full attenuation for out-of-band signals as well as a 5th order GSM-compliant digital highpass filter. A digital side tone mixer provides loopback of the microphones/ADC signal to the DAC/headphone output.

Serial DAC and ADC data is transferred over a flexible digital I<sup>2</sup>S-compatible interface that also supports TDM mode. Mode settings, volume control, and shutdown are programmed through a 2-wire, I<sup>2</sup>C-compatible interface.

The MAX9860 is fully specified over the -40°C to +85°C extended temperature range and is available in a low-profile, 4mm x 4mm, 24-pin thin QFN package.

## Applications

- Audio Headsets
- Portable Navigation Device
- Mobile Phones
- Smart Phones
- VoIP Phones
- Audio Accessories

**Pin Configuration and Typical Operating Circuit appear at end of data sheet.**

## Features

- ◆ 1.8V Single-Supply Operation
- ◆ Digital Highpass Elliptical Filters with Notch for 217Hz (GSM)
- ◆ Mono 30mW BTL Headphone Amplifier
- ◆ Dual Low-Noise Microphone Inputs
- ◆ Automatic Microphone Gain Control and Noise Gate
- ◆ 90dB DAC DR ( $f_s = 48\text{kHz}$ )
- ◆ 81dB ADC DR ( $f_s = 48\text{kHz}$ )
- ◆ Supports Master Clock Frequencies from 10MHz to 60MHz
- ◆ Supports Sample Rates from 8kHz to 48kHz
- ◆ Flexible Digital Audio Interface
- ◆ Clickless/Popless Operation
- ◆ 2-Wire, I<sup>2</sup>C-Compatible Control Interface
- ◆ Available in 24-Pin, Thin QFN, 4mm x 4mm x 0.8mm Package

## Ordering Information

PART	TEMP RANGE	PIN-PACKAGE
MAX9860ETG+	-40°C to +85°C	24 TQFN-EP*

+Denotes a lead-free/RoHS-compliant package.

\*EP = Exposed pad.

## Simplified Block Diagram

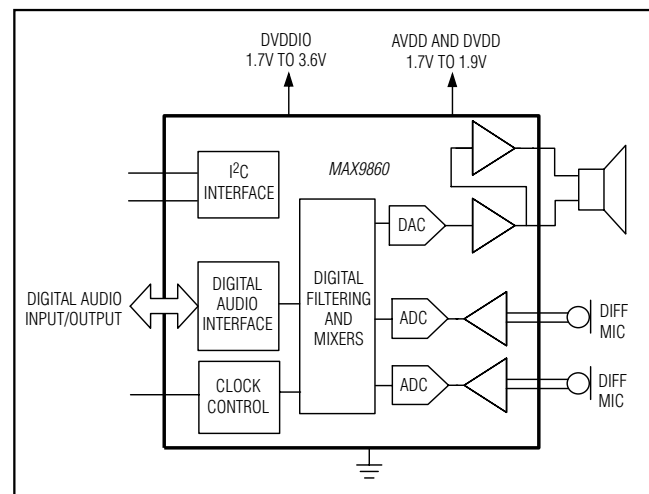

**For pricing, delivery, and ordering information, please contact Maxim Direct at 1-888-629-4642, or visit Maxim's website at [www.maximintegrated.com](http://www.maximintegrated.com).**

# MAX9860

## 16-Bit Mono Audio Voice Codec

### ABSOLUTE MAXIMUM RATINGS

(Voltages referenced to AGND.)

DVDDIO, SDA, SCL, $\overline{\text{IRQ}}$	-0.3V to +3.6V
AVDD, DVDD	-0.3V to +2V
AGND, DGND, MICGND	-0.3V to +0.3V
OUTP, OUTN, PREG, REF, MICBIAS	-0.3V to (VAVDD + 0.3V)
MICLP, MICLN, MICRP, MICRN, REG	-0.3V to (VPREG + 0.3V)
MCLK, LRCLK, BCLK, SDOUT, SDIN	-0.3V to (VDVDDIO + 0.3V)

Continuous Power Dissipation ( $T_A = +70^\circ\text{C}$ )

24-Pin TQFN (derate 27.8mW/ $^\circ\text{C}$ above $+70^\circ\text{C}$ , multilayer board)	2222mW
Operating Temperature Range	-40 $^\circ\text{C}$ to +85 $^\circ\text{C}$
Storage Temperature Range	-65 $^\circ\text{C}$ to +150 $^\circ\text{C}$
Junction Temperature	+150 $^\circ\text{C}$
Lead Temperature (soldering, 10s)	+300 $^\circ\text{C}$
Soldering Temperature (reflow)	+260 $^\circ\text{C}$

Stresses beyond those listed under "Absolute Maximum Ratings" may cause permanent damage to the device. These are stress ratings only, and functional operation of the device at these or any other conditions beyond those indicated in the operational sections of the specifications is not implied. Exposure to absolute maximum rating conditions for extended periods may affect device reliability.

### PACKAGE THERMAL CHARACTERISTICS (Note 1)

TQFN

Junction-to-Ambient Thermal Resistance ( $\theta_{JA}$ )	36 $^\circ\text{C}/\text{W}$
Junction-to-Case Thermal Resistance ( $\theta_{JC}$ )	3 $^\circ\text{C}/\text{W}$

**Note 1:** Package thermal resistances were obtained using the method described in JEDEC specification JESD51-7, using a four-layer board. For detailed information on package thermal considerations, refer to [www.maximintegrated.com/thermal-tutorial](http://www.maximintegrated.com/thermal-tutorial).

### ELECTRICAL CHARACTERISTICS

(VAVDD = VD VDD = VDVDDIO = +1.8V,  $R_L = \infty$ , headphone load ( $R_L$ ) connected between OUTP and OUTN,  $C_{REF} = 2.2\mu\text{F}$ ,  $C_{MICBIAS} = C_{PREG} = C_{REG} = 1\mu\text{F}$ ,  $A_{VPRE} = +20\text{dB}$ ,  $A_{VMICPGA} = 0\text{dB}$ ,  $f_{MCLK} = 13\text{MHz}$ ,  $f_{LRCLK} = 8\text{kHz}$ ,  $T_A = T_{MIN}$  to  $T_{MAX}$ , unless otherwise noted. Typical values are at  $T_A = +25^\circ\text{C}$ .) (Note 2)

PARAMETER	SYMBOL	CONDITIONS	MIN	TYP	MAX	UNITS
Supply Voltage Range		AVDD (inferred from HP output PSRR)	1.7	1.8	1.9	V
		DVDD (inferred from codec performance tests)	1.7	1.8	1.9	
		DVDDIO	1.7	1.8	3.6	
Total Supply Current (Note 3)	$I_{AVDD+DVDD}$	DAC playback mode (48kHz)	AVDD	1.46	2.2	mA
			DVDD	1.05	1.6	
		Full operation 8kHz mono ADC + DAC	AVDD	4.08	5.7	
			DVDD	0.78	1.0	
		Full operation 8kHz stereo ADC + DAC	AVDD	6.17	9.0	
			DVDD	0.8	1.2	
Stereo ADC only (48kHz)	AVDD	5.38	8.0			
	DVDD	1.68	2.2			
Shutdown Supply Current	$I_{SHDN}$	$T_A = +25^\circ\text{C}$	AVDD	0.56	5	$\mu\text{A}$
			DVDD + DVDDIO	1.65	5	
Shutdown to Full Operation				10		ms
<b>DAC (Note 4)</b>						
Gain Error				$\pm 1$	$\pm 5$	%
Dynamic Range (Note 5)	DR	+0dB volume setting, $f_S = 8\text{kHz}$ , measured at headphone output, $T_A = +25^\circ\text{C}$	84	90		dB
DAC Full-Scale Output				1		$V_{RMS}$
DAC Path Phase Delay		f = 1kHz, 0dBFS, HP filter disabled, digital input to analog output	$f_S = 8\text{kHz}$	1.2		ms
			$f_S = 16\text{kHz}$	0.59		
Total Harmonic Distortion + Noise	THD+N	f = 1kHz, $f_{MCLK} = 12.288\text{MHz}$ , $f_{LRCLK} = 48\text{kHz}$		-87		dB

## 16-Bit Mono Audio Voice Codec

### ELECTRICAL CHARACTERISTICS (continued)

( $V_{AVDD} = V_{DVDD} = V_{DVDDIO} = +1.8V$ ,  $R_L = \infty$ , headphone load ( $R_L$ ) connected between OUTP and OUTN,  $C_{REF} = 2.2\mu F$ ,  $C_{MICBIAS} = C_{PREG} = C_{REG} = 1\mu F$ ,  $A_{VPRE} = +20dB$ ,  $A_{VMICPGA} = 0dB$ ,  $f_{MCLK} = 13MHz$ ,  $f_{LRCLK} = 8kHz$ ,  $T_A = T_{MIN}$  to  $T_{MAX}$ , unless otherwise noted. Typical values are at  $T_A = +25^\circ C$ .) (Note 2)

PARAMETER	SYMBOL	CONDITIONS	MIN	TYP	MAX	UNITS
Power-Supply Rejection Ratio	PSRR	$f = 1kHz$ , $V_{RIPPLE} = 100mV_{P-P}$ , $A_{VPGA} = 0dB$		94		dB
		$f = 10kHz$ , $V_{RIPPLE} = 100mV_{P-P}$ , $A_{VPGA} = 0dB$		71		
<b>DAC LOWPASS DIGITAL FILTER</b>						
Passband Cutoff	$f_{PLP}$	With respect to $f_S$ within ripple; $f_S = 8kHz$ to 48kHz		$0.448 \times f_S$		Hz
		-3dB cutoff		0.451		$f_S$
Passband Ripple		$f < f_{PLP}$		$\pm 0.1$		dB
Stopband Cutoff	$f_{SLP}$	With respect to $f_S$ ; $f_S = 8kHz$ to 48kHz		$0.476 \times f_S$		Hz
Stopband Attenuation		$f > f_{SLP}$ , $f = 20Hz$ to 20kHz		75		dB
<b>DAC HIGHPASS DIGITAL FILTER</b>						
5th Order Passband Cutoff (-3dB from Peak, I <sup>2</sup> C Register Programmable) (Note 6)	$f_{DHPPB}$	DVFLT = 0x1 (elliptical for 16kHz GSM)		$0.0161 \times f_S$		Hz
		DVFLT = 0x2 (500Hz Butterworth for 16kHz)		$0.0312 \times f_S$		
		DVFLT = 0x3 (elliptical for 8kHz GSM)		$0.0321 \times f_S$		
		DVFLT = 0x4 (500Hz Butterworth for 8kHz)		$0.0625 \times f_S$		
		DVFLT = 0x5 (200Hz Butterworth for 48kHz)		$0.0042 \times f_S$		
5th Order Stopband Cutoff (-30dB from Peak, I <sup>2</sup> C Register Programmable) (Note 6)	$f_{DHPSB}$	DVFLT = 0x1 (elliptical for 16kHz GSM)		$0.0139 \times f_S$		Hz
		DVFLT = 0x2 (500Hz Butterworth for 16kHz)		$0.0156 \times f_S$		
		DVFLT = 0x3 (elliptical for 8kHz GSM)		$0.0279 \times f_S$		
		DVFLT = 0x4 (500Hz Butterworth for 8kHz)		$0.0312 \times f_S$		
		DVFLT = 0x5 (200Hz Butterworth for 48kHz)		$0.0021 \times f_S$		
DC Blocking	DCAtten	DVFLT $\neq$ 0x0		90		dB
<b>ADC</b>						
Full-Scale Input Voltage	0dBFS	Differential MIC Input, $A_{VPRE} = 0dB$ , $A_{VPGA} = 0dB$		1		$V_{P-P}$
Channel Gain Mismatch				$\pm 0.3$		%

# MAX9860

## 16-Bit Mono Audio Voice Codec

### ELECTRICAL CHARACTERISTICS (continued)

( $V_{AVDD} = V_{DVDD} = V_{DVDDIO} = +1.8V$ ,  $R_L = \infty$ , headphone load ( $R_L$ ) connected between OUTP and OUTN,  $C_{REF} = 2.2\mu F$ ,  $C_{MICBIAS} = C_{PREG} = C_{REG} = 1\mu F$ ,  $A_{VPRE} = +20dB$ ,  $A_{VMICPGA} = 0dB$ ,  $f_{MCLK} = 13MHz$ ,  $f_{LRCLK} = 8kHz$ ,  $T_A = T_{MIN}$  to  $T_{MAX}$ , unless otherwise noted. Typical values are at  $T_A = +25^\circ C$ .) (Note 2)

PARAMETER	SYMBOL	CONDITIONS	MIN	TYP	MAX	UNITS
Dynamic Range (Note 5)	DR	$f_S = 8kHz$ , $A_{VPRE} = 0dB$ , A-weighted from 20Hz to $f_S/2$		81		dB
		$f_S = 48kHz$ , $A_{VPRE} = 0dB$ , $T_A = +25^\circ C$	75	83		
ADC Phase Delay		$f = 1kHz$ , 0dBFS, HP filter disabled, analog input to digital output	$f_S = 8kHz$	1.2		ms
			$f_S = 16kHz$	0.61		
Total Harmonic Distortion	THD	$f = 1kHz$ , $f_S = 48kHz$ , $T_A = +25^\circ C$	-70	-75		dB
Power-Supply Rejection Ratio	PSRR	$f = 1kHz$ , $V_{RIPPLE} = 100mV_{P-P}$ , $A_{VPGA} = 0dB$		82		dB
		$f = 10kHz$ , $V_{RIPPLE} = 100mV_{P-P}$ , $A_{VPGA} = 0dB$		76		
Channel Crosstalk		Driven channel at -1dBFS, $f = 1kHz$		-92		dB
<b>ADC LOWPASS DIGITAL FILTER</b>						
Passband Cutoff	$f_{PLP}$	With respect to $f_S$ within ripple; $f_S = 8kHz$ to 48kHz		$0.445 \times f_S$		Hz
		-3dB cutoff		0.449		
Passband Ripple		$f < f_{PLP}$		$\pm 0.1$		dB
Stopband Cutoff	$f_{SLP}$	With respect to $f_S$ ; $f_S = 8kHz$ to 48kHz		$0.469 \times f_S$		Hz
Stopband Attenuation		$f > f_{SLP}$		74		dB
<b>ADC HIGHPASS DIGITAL FILTER</b>						
5th Order Passband Cutoff (-3dB from Peak, I <sup>2</sup> C Register Programmable) (Note 6)	$f_{AHPPB}$	AVFLT = 0x1 (elliptical for 16kHz GSM)		$0.0161 \times f_S$		Hz
		AVFLT = 0x2 (500Hz Butterworth for 16kHz)		$0.0312 \times f_S$		
		AVFLT = 0x3 (elliptical for 8kHz GSM)		$0.0321 \times f_S$		
		AVFLT = 0x4 (500Hz Butterworth for 8kHz)		$0.0625 \times f_S$		
		AVFLT = 0x5 (200Hz Butterworth for 48kHz)		$0.0042 \times f_S$		

## 16-Bit Mono Audio Voice Codec

### ELECTRICAL CHARACTERISTICS (continued)

( $V_{AVDD} = V_{DVDD} = V_{DVDDIO} = +1.8V$ ,  $R_L = \infty$ , headphone load ( $R_L$ ) connected between OUTP and OUTN,  $C_{REF} = 2.2\mu F$ ,  $C_{MICBIAS} = C_{PREG} = C_{REG} = 1\mu F$ ,  $A_{VPRE} = +20dB$ ,  $A_{VMICPGA} = 0dB$ ,  $f_{MCLK} = 13MHz$ ,  $f_{LRCLK} = 8kHz$ ,  $T_A = T_{MIN}$  to  $T_{MAX}$ , unless otherwise noted. Typical values are at  $T_A = +25^\circ C$ .) (Note 2)

PARAMETER	SYMBOL	CONDITIONS	MIN	TYP	MAX	UNITS
5th Order Stopband Cutoff (-30dB from peak, I <sup>2</sup> C Register Programmable) (Note 6)	f <sub>AHPSB</sub>	AVFLT = 0x1 (elliptical for 16kHz GSM)		0.0139		Hz
		AVFLT = 0x2 (500Hz Butterworth for 16kHz)		0.0156		
		AVFLT = 0x3 (elliptical for 8kHz GSM)		0.0279		
		AVFLT = 0x4 (500Hz Butterworth for 8kHz)		0.0312		
		AVFLT = 0x5 (200Hz Butterworth for 48kHz)		0.0021		
DC Blocking	DC <sub>ATTEN</sub>	AVFLT ≠ 0x0		90		dB
<b>CLOCKING</b>						
MCLK Input Frequency		MCLK is not required to be synchronous or related to the desired LRCLK data rate	10		60	MHz
MCLK Duty Cycle			40	50	60	%
Maximum MCLK Input Jitter		For guaranteed performance limits		100		psRMS
LRCLK Data Rate Frequency			8		48	kHz
LRCLK PLL Lock Time				12	25	ms
LRCLK Acceptable Jitter for Maintaining PLL Lock				±20		ns
<b>MONO HEADPHONE AMPLIFIER</b>						
Output Power	P <sub>OUT</sub>	f = 1kHz, THD+N ≤ 1% T <sub>A</sub> = +25°C	R <sub>L</sub> = 16Ω	30	50	mW
			R <sub>L</sub> = 32Ω		33	
Total Harmonic Distortion + Noise	THD+N	R <sub>L</sub> = 32Ω, P <sub>OUT</sub> = 25mW, f = 1kHz		0.05		%
		R <sub>L</sub> = 16Ω, P <sub>OUT</sub> = 25mW, f = 1kHz		0.08		
Dynamic Range (Note 5)	DR	+0dB volume setting, DAC input at f <sub>S</sub> = 8kHz to 48kHz		90		dB
Power-Supply Rejection Ratio	PSRR	V <sub>AVDD</sub> = 1.7V to 1.9V	60	84		dB
		V <sub>RIPPLE</sub> = 100mV <sub>P-P</sub> , f = 217Hz		86		
		V <sub>RIPPLE</sub> = 100mV <sub>P-P</sub> , f = 20kHz		71		
Output Offset Voltage	V <sub>OS</sub>	V <sub>OUTP</sub> - V <sub>OUTN</sub> , T <sub>A</sub> = +25°C			± 3.5	mV
Capacitive Drive Capability		No sustained oscillations	R <sub>L</sub> = 32Ω	500		pF
			R <sub>L</sub> = ∞	100		
Click-and-Pop Level		Peak voltage into/out of shutdown, 32sps, A-weighted		-70		dBV

# MAX9860

## 16-Bit Mono Audio Voice Codec

### ELECTRICAL CHARACTERISTICS (continued)

( $V_{AVDD} = V_{DVDD} = V_{DVDDIO} = +1.8V$ ,  $R_L = \infty$ , headphone load ( $R_L$ ) connected between OUTP and OUTN,  $C_{REF} = 2.2\mu F$ ,  $C_{MICBIAS} = C_{PREG} = C_{REG} = 1\mu F$ ,  $A_{VPRE} = +20dB$ ,  $A_{VMICPGA} = 0dB$ ,  $f_{MCLK} = 13MHz$ ,  $f_{LRCLK} = 8kHz$ ,  $T_A = T_{MIN}$  to  $T_{MAX}$ , unless otherwise noted. Typical values are at  $T_A = +25^\circ C$ .) (Note 2)

PARAMETER	SYMBOL	CONDITIONS	MIN	TYP	MAX	UNITS	
<b>MICROPHONE AMPLIFIER</b>							
Preamplifier Gain	$A_{VPRE}$	$T_A = +25^\circ C$	PAM = 00	Off		dB	
			PAM = 01	-0.5	0		+0.5
			PAM = 10	19	20		21
			PAM = 11	29	30		31
MIC PGA Gain	$A_{VMICPGA}$	PGAM = 0x14–0x1F	0		dB		
		PGAM = 0x00	+20				
MIC PGA Gain Step Size			1		dB		
Common-Mode Rejection Ratio	CMRR	$V_{IN} = 100mV_{P-P}$ at 217Hz	50		dB		
MIC Input Resistance	$R_{IN\_MIC}$	All gain settings, measured at MICLN/MICRN	30	50		k $\Omega$	
MIC Input Bias Voltage			0.7	0.8	0.9	V	
Total Harmonic Distortion + Noise	THD+N	$A_{VPRE} = 0dB$ , $A_{VMICPGA} = 0dB$ , $V_{IN} = 1V_{P-P}$ , $f = 1kHz$	-75		dB		
		$A_{VPRE} = +30dB$ , $A_{VMICPGA} = 0dB$ , $V_{IN} = 31mV_{P-P}$ , $f = 1kHz$	-66		dB		
MIC Power-Supply Rejection Ratio	PSRR	$V_{AVDD} = 1.7V$ to $1.9V$	60	95		dB	
		$V_{RIPPLE} = 100mV$ at 1kHz, input referred	82		dB		
		$V_{RIPPLE} = 100mV$ at 10kHz, input referred	76		dB		
<b>MICROPHONE BIAS</b>							
MICBIAS Output Voltage	$V_{MICBIAS}$	$I_{LOAD} = 1mA$ , $T_A = +25^\circ C$	1.5	1.55	1.6	V	
Load Regulation		$I_{LOAD} = 1mA$ to $2mA$	0.2		10	mV	
MICBIAS Line Ripple Rejection	LRR	$V_{RIPPLE} = 100mV_{P-P}$ at 217Hz	82		dB		
		$V_{RIPPLE} = 100mV_{P-P}$ at 10kHz	81		dB		
MICBIAS Noise Voltage		A-weighted	9.5		$\mu V_{RMS}$		
<b>AUTOMATIC GAIN CONTROL</b>							
AGC Hold Duration		AGCHLD[1:0] setting range, $FREQ \neq 0$	50	400		ms	
AGC Attack Time		AGCATK[1:0] setting range, $FREQ \neq 0$	3	200		ms	
AGC Release Time		AGCRLS[2:0] setting range, $FREQ \neq 0$	0.078	10		s	
AGC Threshold Level		AGCSTH[3:0] setting range, $FREQ \neq 0$	-3	-18		dB	
<b>NOISE GATE</b>							
NG Attack and Release Time			0.5		s		
NG Threshold Level			-72	-16		dB	
Noise Gate Threshold Step Size			4		dB		
NG Attenuation			0	12		dB	
<b>DIGITAL SIDETONE</b>							
Sidetone Gain Adjust	DVST	2dB steps	-60	0		dB	
Sidetone Phase Delay	PDLY	MIC input to headphone output, $f = 1kHz$ , HP filter disabled	8kHz	2.2		ms	
			16kHz	1.1			

# MAX9860

## 16-Bit Mono Audio Voice Codec

### DIGITAL AUDIO INTERFACE ELECTRICAL CHARACTERISTICS

( $V_{DVDD} = V_{DVDDIO} = 1.8V$ , unless otherwise noted.) (Note 2)

PARAMETER	SYMBOL	CONDITIONS	MIN	TYP	MAX	UNITS
BCLK Cycle Time	$t_{BCLKS}$	Slave operation	75			ns
BCLK High Time	$t_{BCLKH}$	Slave operation	30			ns
BCLK Low Time	$t_{BCLKL}$	Slave operation	30			ns
BCLK or LRCLK Rise and Fall Time	$t_R, t_F$	Master operation		7		ns
SDIN or LRCLK to BCLK Rising Setup Time	$t_{SU}$	ABCI = DBCI = 0	25			ns
SDIN or LRCLK to BCLK Falling Setup Time	$t_{SU}$	ABCI = DBCI = 1	25			ns
SDIN or LRCLK to BCLK Rising Hold Time	$t_{HD}$	ABCI = DBCI = 0	0			ns
SDIN or LRCLK to BCLK Falling Hold Time	$t_{HD}$	ABCI = DBCI = 1	0			ns
SDOUT Delay Time from BCLK Rising Edge	$t_{DLY}$	ABCI = DBCI = 0, $C_L = 30pF$	0		40	ns

### I<sup>2</sup>C INTERFACE ELECTRICAL CHARACTERISTICS

( $V_{DVDD} = V_{DVDDIO} = 1.8V$ , unless otherwise noted.) (Note 2)

PARAMETER	SYMBOL	CONDITIONS	MIN	TYP	MAX	UNITS
Serial-Clock Frequency	$f_{SCL}$		0		400	kHz
Bus Free Time Between STOP and START Conditions	$t_{BUF}$		1.3			$\mu s$
Hold Time (Repeated) START Condition	$t_{HD,STA}$		0.6			$\mu s$
SCL Pulse Width Low	$t_{LOW}$		1.3			$\mu s$
SCL Pulse Width High	$t_{HIGH}$		0.6			$\mu s$
Setup Time for a Repeated START Condition	$t_{SU,STA}$		0.6			$\mu s$
Data Hold Time	$t_{HD,DAT}$		0		900	ns
Data Setup Time	$t_{SU,DAT}$		100			ns
SDA and SCL Receiving Rise Time	$t_R$	$C_B$ is in pF	$20 + 0.1C_B$		300	ns
SDA and SCL Receiving Fall Time	$t_F$	$C_B$ is in pF	$20 + 0.1C_B$		300	ns

# MAX9860

## 16-Bit Mono Audio Voice Codec

### I<sup>2</sup>C INTERFACE ELECTRICAL CHARACTERISTICS (continued)

(V<sub>DVDD</sub> = V<sub>DVDDIO</sub> = 1.8V, unless otherwise noted.) (Note 2)

PARAMETER	SYMBOL	CONDITIONS	MIN	TYP	MAX	UNITS
SDA Transmitting Fall Time	t <sub>F</sub>	C <sub>B</sub> is in pF	20 + 0.1C <sub>B</sub>		250	ns
Setup Time for STOP Condition	t <sub>SU,STO</sub>		0.6			μs
Bus Capacitance	C <sub>B</sub>				400	pF
Pulse Width of Suppressed Spike	t <sub>SP</sub>		0		50	ns
<b>DIGITAL INPUTS (LRCLK, BCLK, SDIN, MCLK)</b>						
Input Voltage High	V <sub>IH</sub>		0.7 x V <sub>DVDDIO</sub>			V
Input Voltage Low	V <sub>IL</sub>			0.3 x V <sub>DVDDIO</sub>		V
MCLK Input Voltage High			1.4			V
MCLK Input Voltage Low				0.4		V
Input Leakage Current	I <sub>IH</sub> , I <sub>IL</sub>	T <sub>A</sub> = +25°C	-1		+1	μA
Input Capacitance				3		pF
<b>DIGITAL INPUTS (SCL, SDA)</b>						
Input Voltage High	V <sub>IH</sub>		0.7 x V <sub>DVDD</sub>			V
Input Voltage Low	V <sub>IL</sub>			0.3 x V <sub>DVDD</sub>		V
Input Hysteresis				200		mV
Input Leakage Current	I <sub>IH</sub> , I <sub>IL</sub>	T <sub>A</sub> = +25°C	-1		+1	μA
Input Capacitance				3		pF
<b>CMOS DIGITAL OUTPUTS (BCLK, LRCLK, SDOUT)</b>						
Output Low Voltage	V <sub>OL</sub>	I <sub>OL</sub> = 3mA			0.4	V
Output High Voltage	V <sub>OH</sub>	I <sub>OL</sub> = 3mA	V <sub>DVDDIO</sub> - 0.4			V
<b>OPEN-DRAIN DIGITAL OUTPUTS (SDA, <math>\overline{\text{IRQ}}</math>)</b>						
Output High Leakage Current	I <sub>OH</sub>	V <sub>OUT</sub> = V <sub>DVDDIO</sub> , T <sub>A</sub> = +25°C	-1		+1	μA
Output Low Voltage	V <sub>OL</sub>	I <sub>OL</sub> = 3mA			0.4	V

**Note 2:** All devices are 100% production tested at room temperature. All temperature limits are guaranteed by design.

**Note 3:** Supply current measurements taken with no applied signal at microphone inputs. A digital zero audio signal used for all digital serial audio inputs. Headphone outputs are loaded as stated in the global conditions.

**Note 4:** DAC performance is measured at headphone outputs.

**Note 5:** ADC, DAC, and headphone amplifier dynamic ranges are measured using the EIAJ method. -60dBV 1kHz input signal, A-weighted and normalized to 0dBFS.

**Note 6:** Notch for GSM filters occurs at 217Hz.



## 16-Bit Mono Audio Voice Codec

### Typical Operating Characteristics

( $V_{AVDD} = +1.8V$ ,  $V_{DVDD} = V_{DVDDIO} = +1.8V$ ,  $R_L = \infty$ , headphone load ( $R_L$ ) connected between OUP and OUTN,  $C_{REF} = 2.2\mu F$ ,  $C_{PREG} = C_{REG} = 1\mu F$ ,  $C_{MICBIAS} = 1\mu F$ ,  $A_{VMICPGA} = 0dB$ ,  $A_{VPRE} = +20dB$ ,  $f_{MCLK} = 13MHz$ ,  $T_A = +25^\circ C$ , unless otherwise noted.)

**TOTAL HARMONIC DISTORTION + NOISE vs. OUTPUT POWER (DAC TO HP)**

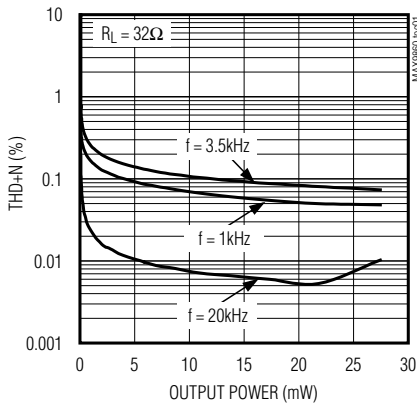

**TOTAL HARMONIC DISTORTION + NOISE vs. OUTPUT POWER (DAC TO HP)**

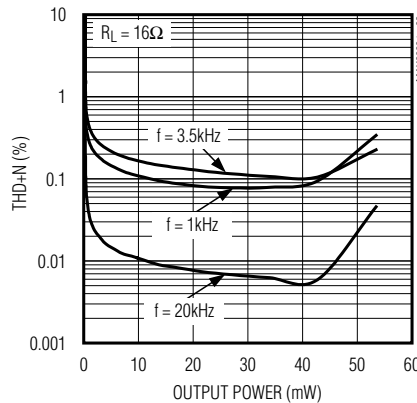

**TOTAL HARMONIC DISTORTION + NOISE vs. FREQUENCY (DAC TO HP)**

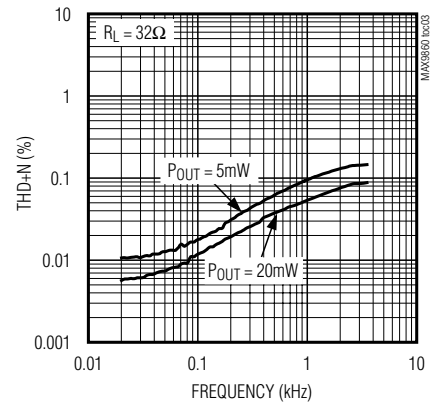

**TOTAL HARMONIC DISTORTION + NOISE vs. FREQUENCY (DAC TO HP)**

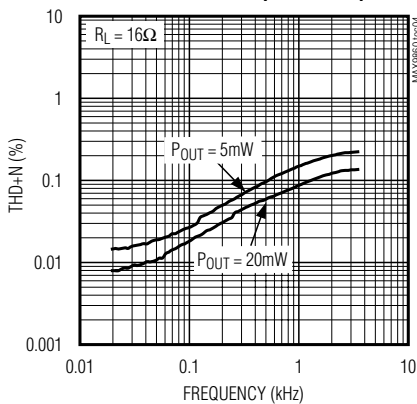

**TOTAL HARMONIC DISTORTION + NOISE vs. FREQUENCY (MICL TO ADC)**

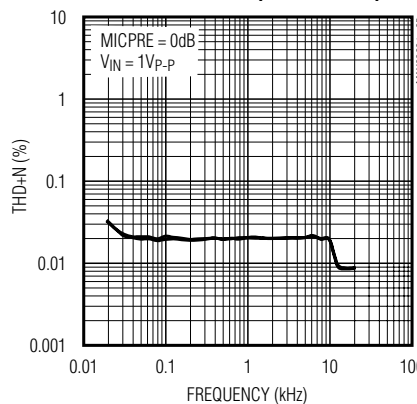

**TOTAL HARMONIC DISTORTION + NOISE vs. FREQUENCY (MICL TO ADC)**

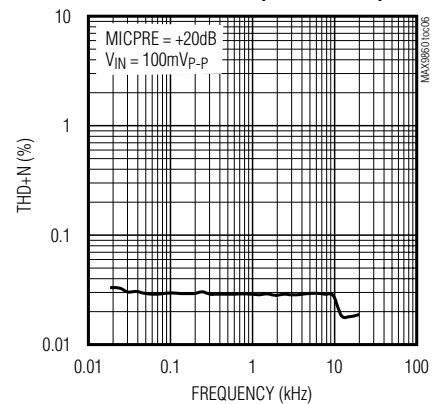

**TOTAL HARMONIC DISTORTION + NOISE vs. FREQUENCY (MICL TO ADC)**

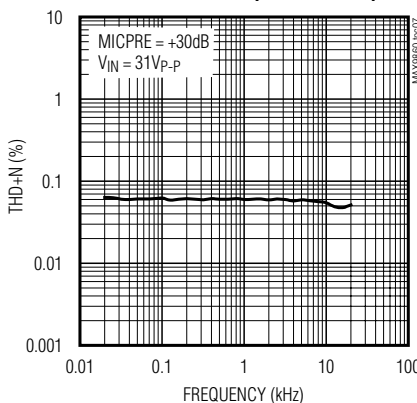

**HEADPHONE OUTPUT POWER vs. LOAD RESISTANCE**

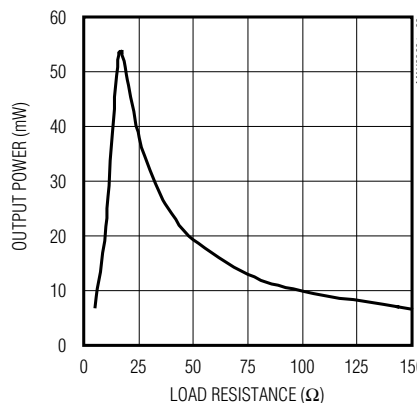

**POWER-SUPPLY REJECTION RATIO vs. FREQUENCY (DAC TO HP)**

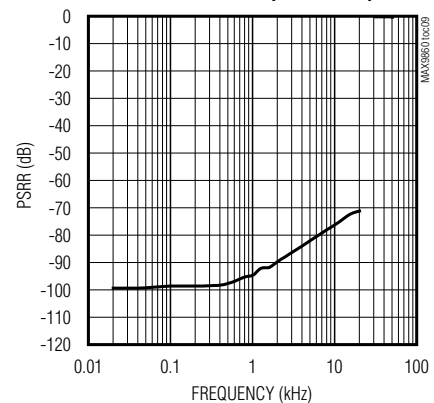

# MAX9860

## 16-Bit Mono Audio Voice Codec

### Typical Operating Characteristics (continued)

( $V_{AVDD} = +1.8V$ ,  $V_{DVDD} = V_{DVDDIO} = +1.8V$ ,  $R_L = \infty$ , headphone load ( $R_L$ ) connected between OUTP and OUTN,  $C_{REF} = 2.2\mu F$ ,  $C_{PRE} = C_{REG} = 1\mu F$ ,  $C_{MICBIAS} = 1\mu F$ ,  $A_{VMICPGA} = 0dB$ ,  $A_{VPRE} = +20dB$ ,  $f_{MCLK} = 13MHz$ ,  $T_A = +25^\circ C$ , unless otherwise noted.)

**POWER-SUPPLY REJECTION RATIO  
vs. FREQUENCY (MIC TO ADC)**

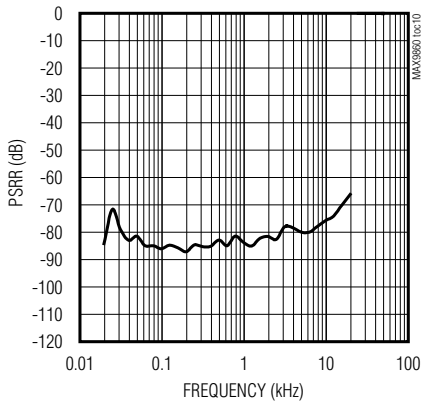

**0dBFS FFT (DAC TO HP)**

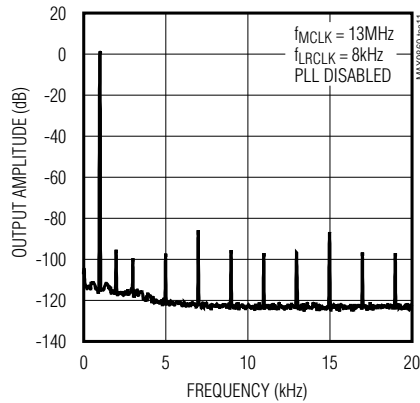

**-60dBFS FFT (DAC TO HP)**

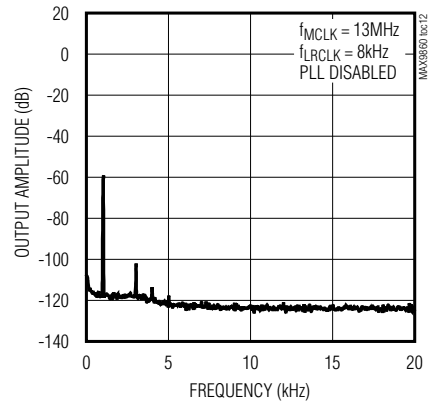

**0dBFS FFT (DAC TO HP)**

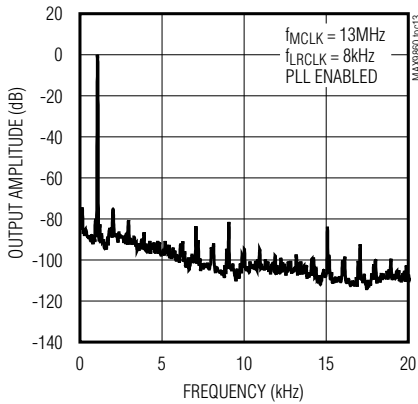

**-60dBFS FFT (DAC TO HP)**

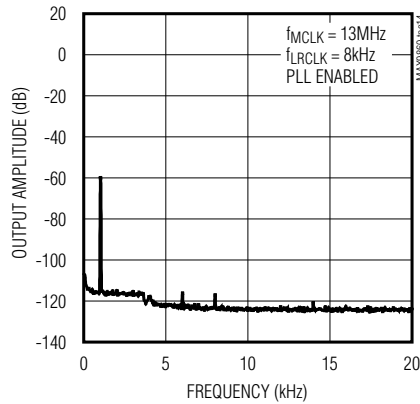

**0dBFS FFT (DAC TO HP AMP)**

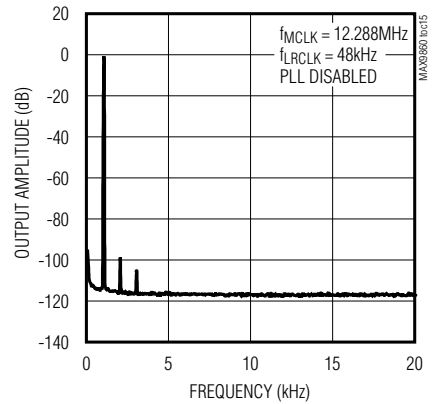

**-60dBFS FFT (DAC TO HP AMP)**

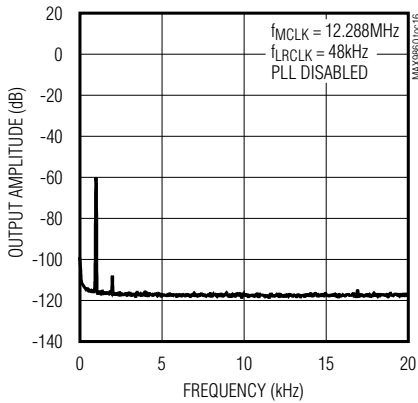

**0dBFS FFT (MICL TO ADC)**

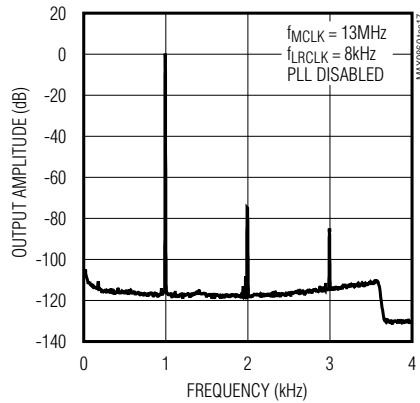

**-60dBFS FFT (MICL TO ADC)**

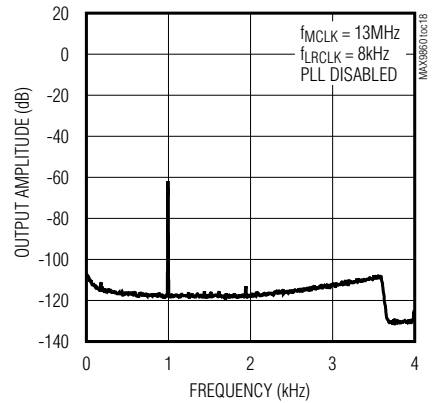

# MAX9860

## 16-Bit Mono Audio Voice Codec

### Typical Operating Characteristics (continued)

( $V_{AVDD} = +1.8V$ ,  $V_{DVDD} = V_{DVDDIO} = +1.8V$ ,  $R_L = \infty$ , headphone load ( $R_L$ ) connected between OUTP and OUTN,  $C_{REF} = 2.2\mu F$ ,  $C_{PREG} = C_{REG} = 1\mu F$ ,  $C_{MICBIAS} = 1\mu F$ ,  $A_{VMICPGA} = 0dB$ ,  $A_{VPRE} = +20dB$ ,  $f_{MCLK} = 13MHz$ ,  $T_A = +25^\circ C$ , unless otherwise noted.)

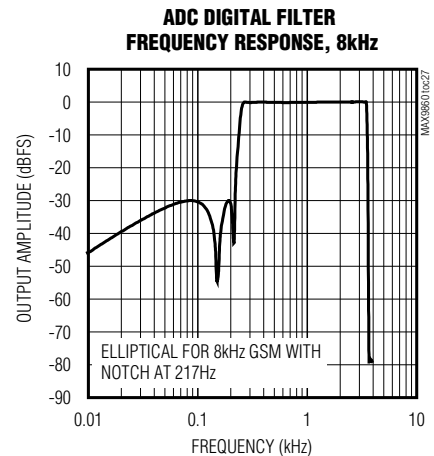
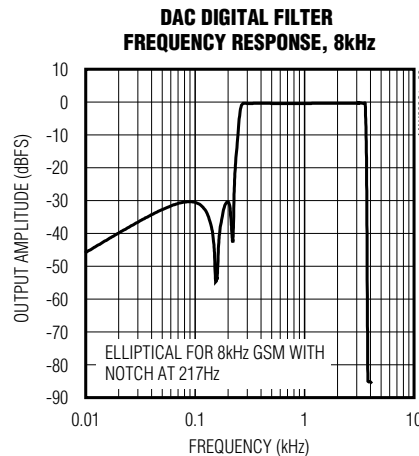
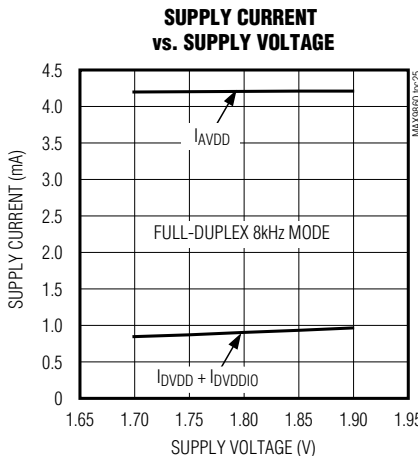
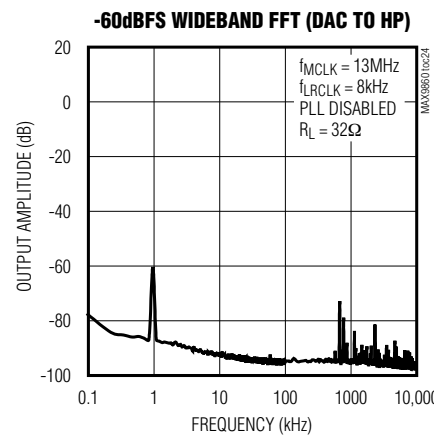
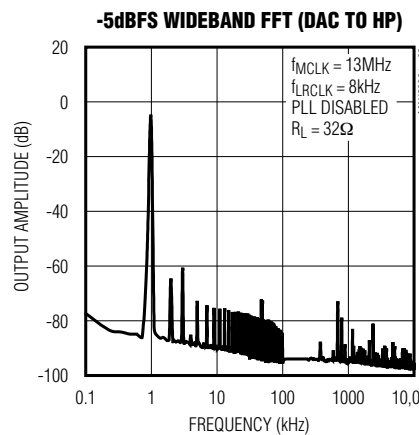
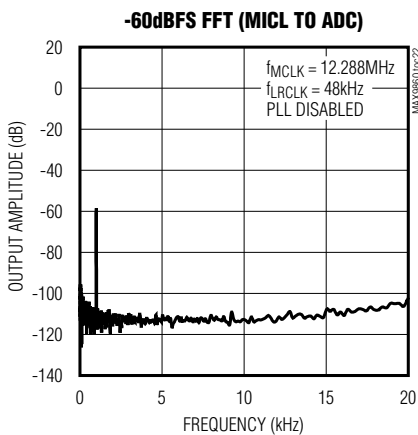
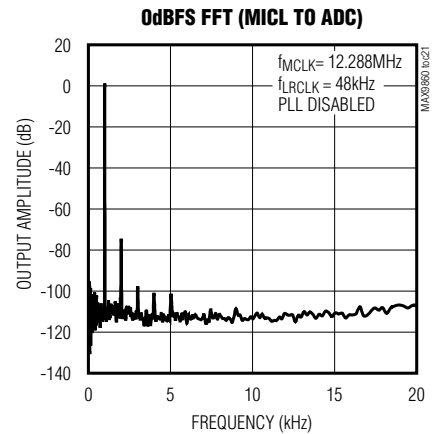
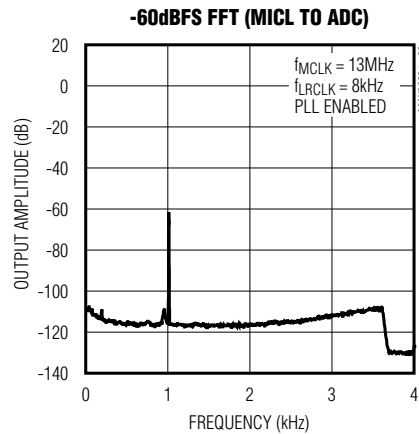
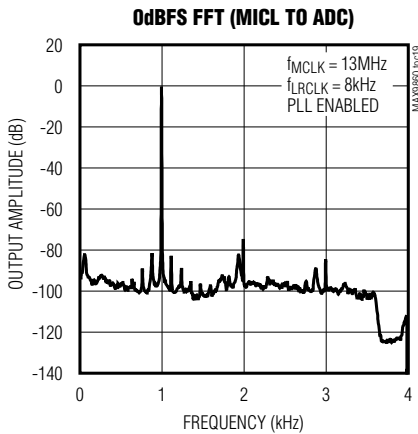

# MAX9860

## 16-Bit Mono Audio Voice Codec

### Typical Operating Characteristics (continued)

( $V_{AVDD} = +1.8V$ ,  $V_{DVDD} = V_{DVDDIO} = +1.8V$ ,  $R_L = \infty$ , headphone load ( $R_L$ ) connected between OUTP and OUTN,  $C_{REF} = 2.2\mu F$ ,  $C_{PREG} = C_{REG} = 1\mu F$ ,  $C_{MICBIAS} = 1\mu F$ ,  $A_{VMICPGA} = 0dB$ ,  $A_{VPRE} = +20dB$ ,  $f_{MCLK} = 13MHz$ ,  $T_A = +25^\circ C$ , unless otherwise noted.)

**HEADPHONE STARTUP WAVEFORM**

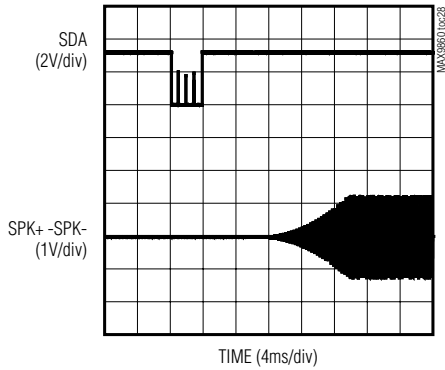

**HEADPHONE SHUTDOWN WAVEFORM**

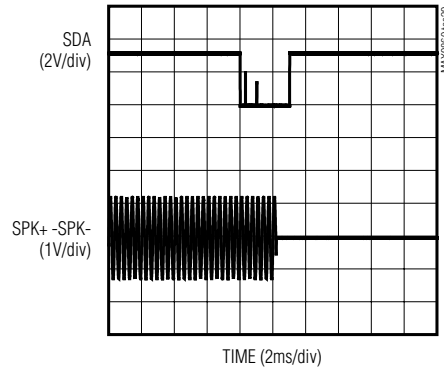

**SOFT-START ADC**

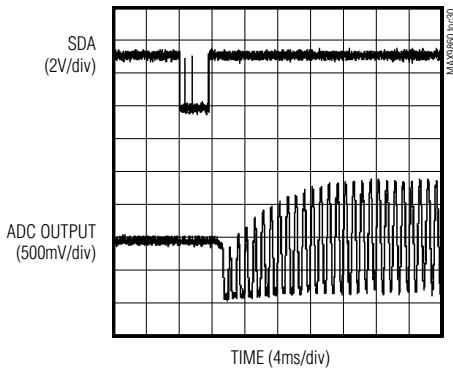

**AUTOMATIC GAIN CONTROL THRESHOLDS**

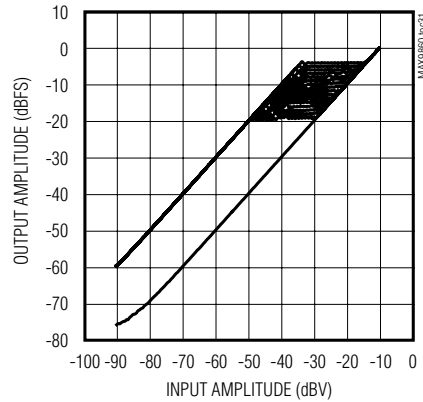

**NOISE GATE THRESHOLDS**

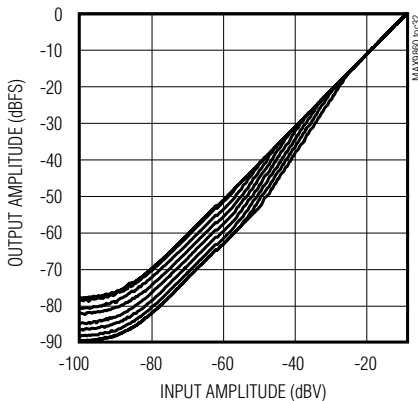

**TOTAL HARMONIC DISTORTION + NOISE vs. MCLK FREQUENCY, 0dBFS (DAC to HP)**

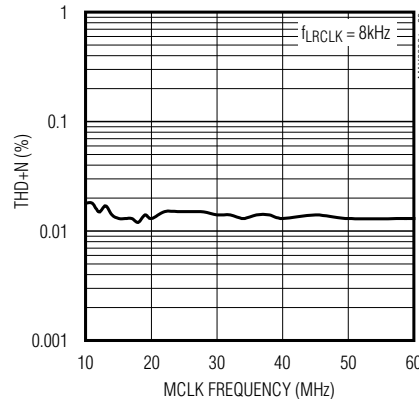

**DYNAMIC RANGE vs. MCLK FREQUENCY, -60dBFS (DAC to HP)**

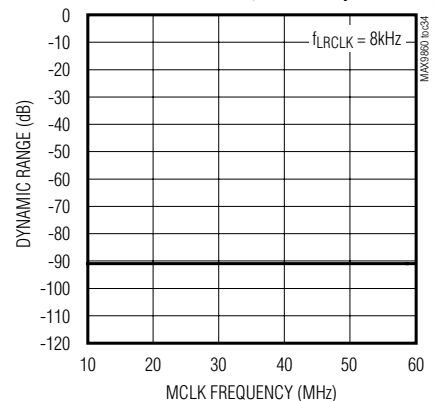

# MAX9860

## 16-Bit Mono Audio Voice Codec

### Pin Description

PIN	NAME	FUNCTION
1	MICBIAS	Microphone Bias. +1.55V microphone bias for internal and/or external microphone. An external resistor from 2.2k $\Omega$ to 470 $\Omega$ should be used to set the microphone current. Bypass to MICGND with a 1 $\mu$ F capacitor.
2	REG	Internal Bias. PREG/2 voltage reference. Bypass to AGND with a 1 $\mu$ F capacitor (+0.8V).
3	PREG	Positive Internal Regulated Supply. Bypass to AGND with a 1 $\mu$ F capacitor (+1.6V).
4	REF	Converter Reference (1.23V). Bypass to AGND with a 2.2 $\mu$ F capacitor.
5	AGND	Analog Ground
6	AVDD	Analog Power Supply. Bypass to AGND with 10 $\mu$ F and 0.1 $\mu$ F capacitors.
7	OUTP	Positive Headphone Output
8	OUTN	Negative Headphone Output
9	SDA	I <sup>2</sup> C Serial-Data Input/Output
10	SCL	I <sup>2</sup> C Serial-Data Clock
11	DVDDIO	Digital Interface Power Supply. Supply for digital audio interface. Bypass to DGND with a 1 $\mu$ F capacitor.
12	DGND	Digital Ground
13	DVDD	Digital Core Power Supply. Bypass to DGND with a 1 $\mu$ F capacitor.
14	MCLK	Master Clock Input
15	SDOUT	Serial Audio Interface ADC Data Output
16	SDIN	Serial Audio Interface DAC Data Input
17	LRCLK	Serial Audio Interface Left/Right Clock
18	BCLK	Serial Audio Interface Bit Clock
19	$\overline{\text{IRQ}}$	Interrupt Request. $\overline{\text{IRQ}}$ is an active-low open drain output. Pull up to DVDDIO with a 10k $\Omega$ resistor.
20	MICRN	Negative Right Microphone Input. AC-couple to low-side of microphone or connect to negative signal. AC-couple to ground for single-ended operation.
21	MICRP	Positive Right Microphone Input. AC-couple to high-side of microphone or connect to positive signal. AC-couple the signal for single-ended operation.
22	MICLN	Negative Left Microphone Input. AC-couple to low-side of microphone or connect to negative signal. AC-couple to ground for single-ended operation.
23	MICLP	Positive Left Microphone Input. AC-couple to high-side of microphone or connect to positive signal. AC-couple the signal for single-ended operation.
24	MICGND	MICBIAS Ground. Connect to AGND.
—	EP	Exposed Pad. Connect to AGND.

# MAX9860

## 16-Bit Mono Audio Voice Codec

### **Detailed Description**

The MAX9860 low-power, voiceband, mono audio codec provides a complete audio solution for wireless voice headsets and other mono audio devices.

The mono playback path accepts digital audio over a flexible digital audio interface compatible with I<sup>2</sup>S, TDM, and left-justified audio signals. An oversampling sigma-delta DAC converts an incoming digital data stream to analog audio and outputs through the mono bridge-tied load headphone amplifier.

The stereo record path has two microphone inputs with selectable gain. The microphones are powered by an integrated microphone bias. An oversampling sigma-delta ADC converts the microphone signals and outputs the digital bit stream over the digital audio interface.

The record path includes automatic gain control (AGC) to optimize the signal level and a noise gate to reduce idle noise. The automatic gain control monitors the outputs of the ADC and makes constant adjustments to the input gain to reduce the dynamic range of the incoming microphone signal by up to 20dB. The noise gate corrects for the increase in noise typically associated with AGC by lowering the gain when there is no audio signal.

Integrated digital filtering provides a range of notch and highpass filters for both the playback and record paths

to limit undesirable low-frequency signals and GSM transmission noise. The digital filtering provides attenuation of out-of-band energy by up to 76dB, eliminating audible aliasing. A digital sidetone function allows audio from the record path to be summed into the playback path after digital filtering.

The MAX9860's flexible clock circuitry utilizes a programmable clock divider and a digital PLL to allow the DAC and ADC to operate at maximum dynamic range for all combinations of master clock (MCLK) and sample rate (LRCLK). Any master clock between 10MHz to 60MHz is supported as are all sample rates from 8kHz to 48kHz. Master and slave mode are supported for maximum flexibility.

### **I<sup>2</sup>C Registers**

The MAX9860 audio codec is completely controlled through software using an I<sup>2</sup>C interface. The power-on default setting is software shutdown, requiring that the internal registers be programmed to activate the device. See Table 1 for the device's complete register map.

### **I<sup>2</sup>C Slave Address**

The MAX9860 responds to the slave address 0x20 for all write commands and 0x21 for all read operations.

# MAX9860

## 16-Bit Mono Audio Voice Codec

**Table 1. I<sup>2</sup>C Register Map**

REGISTER	B7	B6	B5	B4	B3	B2	B1	B0	REGISTER ADDRESS	POR	R/W
<b>STATUS/INTERRUPT</b>											
Interrupt Status	CLD	SLD	ULK	0	0	0	0	0	0x00	—	R
Microphone NG/AGC Readback	NG			AGC					0x01	—	R
Interrupt Enable	ICLD	ISLD	IULK	0	0	0	0	0	0x02	0x00	R/W
<b>CLOCK CONTROL</b>											
System Clock	0	0	PSCLK	0	FREQ	16KHZ	0x03			0x00	R/W
Stereo Audio Clock Control High	PLL	NHI						0x04	0x00	R/W	
Stereo Audio Clock Control Low	NLO						0x05	0x00	R/W		
<b>DIGITAL AUDIO INTERFACE</b>											
Interface	MAS	WCI	DBCI	DDLY	HIZ	TDM	0	0	0x06	0x00	R/W
Interface	0	0	ABCI	ADLY	ST	BSEL			0x07	0x00	R/W
<b>DIGITAL FILTERING</b>											
Voice Filter	AVFLT				DVFLT				0x08	0x00	R/W
<b>DIGITAL LEVEL CONTROL</b>											
DAC Attenuation	DVA						0x09	0x00	R/W		
ADC Output Levels	ADCRL				ADCLL				0x0A	0x00	R/W
DAC Gain and Sidetone	0	DVG	DVST					0x0B	0x00	R/W	
<b>MICROPHONE LEVEL CONTROL</b>											
Microphone Gain	0	PAM	PGAM					0x0C	0x00	R/W	
<b>RESERVED</b>											
Reserved	0	0	0	0	0	0	0	0	0x0D	0x00	
<b>MICROPHONE AUTOMATIC GAIN CONTROL</b>											
Microphone AGC	AGCSRC	AGCRLS			AGCATK		AGCHLD		0x0E	0x00	R/W
Noise Gate, Microphone AGC	ANTH				AGCTH				0x0F	0x00	R/W
<b>POWER MANAGEMENT</b>											
System Shutdown	SHDN	0	0	0	DACEN	0	ADCLEN	ADCREN	0x10	0x00	R/W

# MAX9860

## 16-Bit Mono Audio Voice Codec

### Status/Interrupt

Status registers 0x00 and 0x01 are read-only registers that report the status of various device functions. The status register bits are cleared upon a read operation of the status register and are set the next time the event occurs. Register 0x02 determines whether or not the status flags in register 0x00 simultaneously sets  $\overline{IRQ}$  high.

**Table 2. Status/Interrupt Registers**

REGISTER ADDRESS	B7	B6	B5	B4	B3	B2	B1	B0
0x00	CLD	SLD	ULK	0	0	0	0	0
0x01	NG			AGC				
0x02	ICLD	ISLD	IULK	0	0	0	0	0

BITS	FUNCTION	
CLD	Clip Detect Flag. Indicates that a signal has become clipped in the ADC or DAC digital signal paths. CLD also indicates that the AGC function, when enabled, has set the microphone PGA to 0dB and no further gain reduction is possible.	
SLD	Slew Level Detect Flag. When volume or gain changes are made, the slewing circuitry smoothly steps through all intermediate settings. When SLD is set high, all slewing has completed and the volume or gain is at its final value.	
ULK	Digital PLL Unlock Flag. Indicates that the digital audio PLL for the ADC or DAC has become unlocked and digital signal data is not reliable. When beginning operation in master mode, this flag goes high and can be cleared by reading the status register.	
NG	Noise Gate Attenuation. When the noise gate is enabled these bits indicate the current noise gate attenuation.	
	Code	Attenuation
	000	0dB
	001	1dB
	010	2dB
	011	3dB
	100	6dB
	101	8dB
110	10dB	
111	12dB	
AGC	AGC Gain. When the AGC is enabled these bits indicate the AGC controlled level to the MIC preamp. The levels indicated by these bits correspond to the levels defined for the PGAM bits described in register 0x0C.	



## 16-Bit Mono Audio Voice Codec

### Clock Control

The MAX9860 can work with a master clock (MCLK) supplied from any system clock within the range of 10MHz to 60MHz. Internally, the MAX9860 requires a 10MHz to 20MHz clock so a prescaler divides by 1, 2, or 4 to create the internal clock (PCLK). PCLK is used to clock all portions of the MAX9860.

The MAX9860 is capable of supporting any sample rate from 8kHz to 48kHz, including all common sample rates (8kHz, 16kHz, 24kHz, 32kHz, 44.1kHz, 48kHz). To accommodate a wide range of system architectures, the MAX9860 supports three main clocking modes:

**Normal Mode:** This mode uses a 15-bit clock divider coefficient to set the sample rate relative to the

prescaled MCLK input (PCLK). This allows high flexibility in both the MCLK and LRCLK frequencies and can be used in either master or slave mode.

**Exact Integer Mode:** Common MCLK frequencies (12MHz, 13MHz, and 19.2MHz) can be programmed to operate in exact integer mode for both 8kHz and 16kHz sample rates. In these modes, the MCLK and LRCLK rates are selected by using the FREQ and 16KHZ bits instead of the NHI, NLO, and PLL control bits.

**PLL Mode:** When operating in slave mode, a PLL can be enabled to lock onto externally generated LRCLK signals that are asynchronously related to PCLK.

**Table 3. Clock Control Registers**

REGISTER ADDRESS	B7	B6	B5	B4	B3	B2	B1	B0
0x03	0	0	PSCCLK		0	FREQ		16KHZ
0x04	PLL	NHI						
0x05	NLO							

BITS	FUNCTION
PSCLK[1:0]	<p><b>MCLK Prescaler</b> Divides MCLK down to generate a PCLK between 10MHz and 20MHz.</p> <p>00 = Disable clock for low-power shutdown. 01 = Select if MCLK is between 10MHz and 20MHz. 10 = Select if MCLK is between 20MHz and 40MHz. 11 = Select if MCLK is greater than 40MHz.</p>
FREQ[1:0]	<p><b>Integer Clock Mode</b> Enables exact integer mode for three predefined PCLK frequencies. Exact integer mode is normally intended for master mode, but can be enabled in slave mode if the externally supplied LRCLK exactly matches the frequency specified in each mode.</p> <p>00 = Normal operation (configure clocking with the PLL, NHI, and NLO bits). 01 = Select when PCLK is 12MHz (LRCLK = PCLK/1500 or PCLK/750). 10 = Select when PCLK is 13MHz (LRCLK = PCLK/1625 or PCLK/812.5). 11 = Select when PCLK is 19.2MHz (LRCLK = PCLK/2400 or PCLK/1200).</p> <p>When FREQ ≠ 00, the PLL, NHI, and NLO bits are unused.</p>
16KHZ	<p><b>16kHz Mode</b> When FREQ ≠ 00: 0 = LRCLK is exactly 8kHz. 1 = LRCLK is exactly 16kHz.</p> <p>When FREQ = 00, 16KHZ is used to set the AGC clock rate: 0 = Use when LRCLK ≤ 24kHz. 1 = Use when LRCLK &gt; 24kHz.</p>

# MAX9860

## 16-Bit Mono Audio Voice Codec

**Table 3. Clock Control Registers (continued)**

BITS	FUNCTION
PLL	<p><b>PLL Enable</b>            0 = (Valid for slave and master mode)—The frequency of LRCLK is set by the NHI and NLO divider bits. Set PLL = 0 in slave mode only if the externally generated LRCLK can be exactly selected using the LRCLK divider.</p> <p>1 = (Valid for slave mode only)—Used when the audio master generates an LRCLK not selectable using the LRCLK divider. A digital PLL locks on to the externally supplied LRCLK signal regardless of the MCLK frequency.</p> <p><b>Rapid Lock Mode</b>            To enable rapid lock mode set NHI and NLO to the nearest desired ratio and set NLO[0] = 1 (Register 0x05, bit 0) before setting the PLL mode bit.</p>
NHI and NLO	<p><b>LRCLK Divider</b>            NHI and NLO control a 15-bit clock divider (N). When the PLL = 0 and FREQ = 00, the frequency of LRCLK is determined by the clock divider. See Table 4 for common N values.</p> <p><math>N = (65,536 \times 96 \times f_{LRCLK}) / f_{PCLK}</math>  <math>f_{LRCLK}</math> = LRCLK frequency  <math>f_{PCLK}</math> = prescaled MCLK internal clock frequency (PCLK)</p>

**Table 4. Common N Values**

MCLK (MHz)	LRCLK (kHz)					
	PSCLK	8	16	32	44.1	48
<b>11.2896</b>	01	116A	22D4	45A9	<b>6000</b>	687D
<b>12</b>	01	1062	20C5	4189	5A51	624E
<b>12.288</b>	<b>01</b>	<b>1000</b>	<b>2000</b>	<b>4000</b>	5833	<b>6000</b>
<b>13</b>	01	F20	1E3F	3C7F	535F	5ABE
<b>19.2</b>	01	A3D	147B	28F6	3873	3D71
<b>24</b>	10	1062	20C5	4189	5A51	624E
<b>26</b>	10	F20	1E3F	3C7F	535F	5ABE
<b>27</b>	10	E90	1D21	3A41	5048	5762

**Note:** Values in bold italics are exact integers that provide maximum full-scale performance.

## 16-Bit Mono Audio Voice Codec

### Digital Audio Interface

The MAX9860's digital audio interface supports a wide range of operating modes to ensure maximum compatibility. See Figures 1 through 4 for timing diagrams. In

master mode, the MAX9860 outputs LRCLK and BCLK, while in slave mode, they are inputs. When operating in master mode, BCLK can be configured in a number of ways to ensure compatibility with other audio devices.

**Table 5. Digital Audio Interface Registers**

REGISTER ADDRESS	B7	B6	B5	B4	B3	B2	B1	B0
0x06	MAS	WCI	DBCI	DDLY	HIZ	TDM	0	0
0x07	0	0	ABCI	ADLY	ST	BSEL		

BITS	FUNCTION
MAS	<b>Master Mode</b> 0 = The MAX9860 operates in slave mode with LRCLK and BCLK configured as inputs. 1 = The MAX9860 operates in master mode with LRCLK and BCLK configured as outputs.
WCI	<b>LRCLK Invert</b> 0 = Left-channel data is input and output while LRCLK is low. 1 = Right-channel data is input and output while LRCLK is low.  WCI is ignored when TDM = 1.
DBCI	<b>DAC BCLK Invert (must be set to ABCI)</b> In master and slave mode: 0 = SDIN is latched into the part on the rising edge of BCLK. 1 = SDIN is latched into the part on the falling edge of BCLK.  In master mode: 0 = LRCLK changes state following the rising edge of BCLK. 1 = LRCLK changes state following the falling edge of BCLK.
DDLY	<b>DAC Delay Mode</b> 0 = SDIN data is latched on the first BCLK edge following an LRCLK edge. 1 = SDIN data is assumed to be delayed one BCLK cycle so that it is latched on the 2nd BCLK edge following an LRCLK edge (I <sup>2</sup> S-compatible mode).  DDLY is ignored when TDM = 1.
HIZ	<b>SDOUT High-Impedance Mode</b> 0 = SDOUT is set either high or low after all data bits have been transferred out of the part. 1 = SDOUT goes to a high-impedance state after all data bits have been transferred out of the part, allowing SDOUT to be shared by other devices.  Use HIZ only when TDM = 1.
TDM	<b>TDM Mode Select</b> 0 = LRCLK signal polarity indicates left and right audio. 1 = LRCLK is a framing pulse which transitions polarity to indicate the start of a frame of audio data consisting of multiple channels.  When operating in TDM mode the left channel is output immediately following the frame sync pulse. If right-channel data is being transmitted, the 2nd channel of data immediately follows the 1st channel data.
ABCI	<b>ADC BCLK Invert (must be set to DBCI)</b> 0 = SDOUT is valid on the rising edge of BCLK and transitions immediately after the rising edge. 1 = SDOUT is valid on the falling edge of BCLK and transitions immediately after the falling edge.

# MAX9860

## 16-Bit Mono Audio Voice Codec

**Table 5. Digital Audio Interface Registers (continued)**

BITS	FUNCTION
ADLY	<b>ADC Delay Mode</b> 0 = SDOUT data is valid on the first BCLK edge following an LRCLK edge. 1 = SDOUT data is delayed one BCLK cycle so that it is valid on the 2nd BCLK edge following an LRCLK edge (I <sup>2</sup> S-compatible mode).  ADLY is ignored when TDM = 1.
ST	<b>Stereo Enable</b> 0 = The interface transmits and receives only one channel of data. If right record path is enabled, no data from this channel is transmitted. 1 = The interface operates in stereo. The left and right incoming data are summed to mono and then routed to the DAC. The summed data is divided by 2 to prevent overload. Both the left and right record signals are transmitted.
BSEL	<b>BCLK Select</b> Configures BCLK when operating in master mode. BSEL has no effect in slave mode. Set BSEL = 010, unless sharing the bus with multiple devices.  000 = Off 001 = 64x LRCLK (192x internal clock divided by 3) 010 = 48x LRCLK (192x internal clock divided by 4) 011 = Reserved for future use. 100 = PCLK/2 101 = PCLK/4 110 = PCLK/8 111 = PCLK/16

## 16-Bit Mono Audio Voice Codec

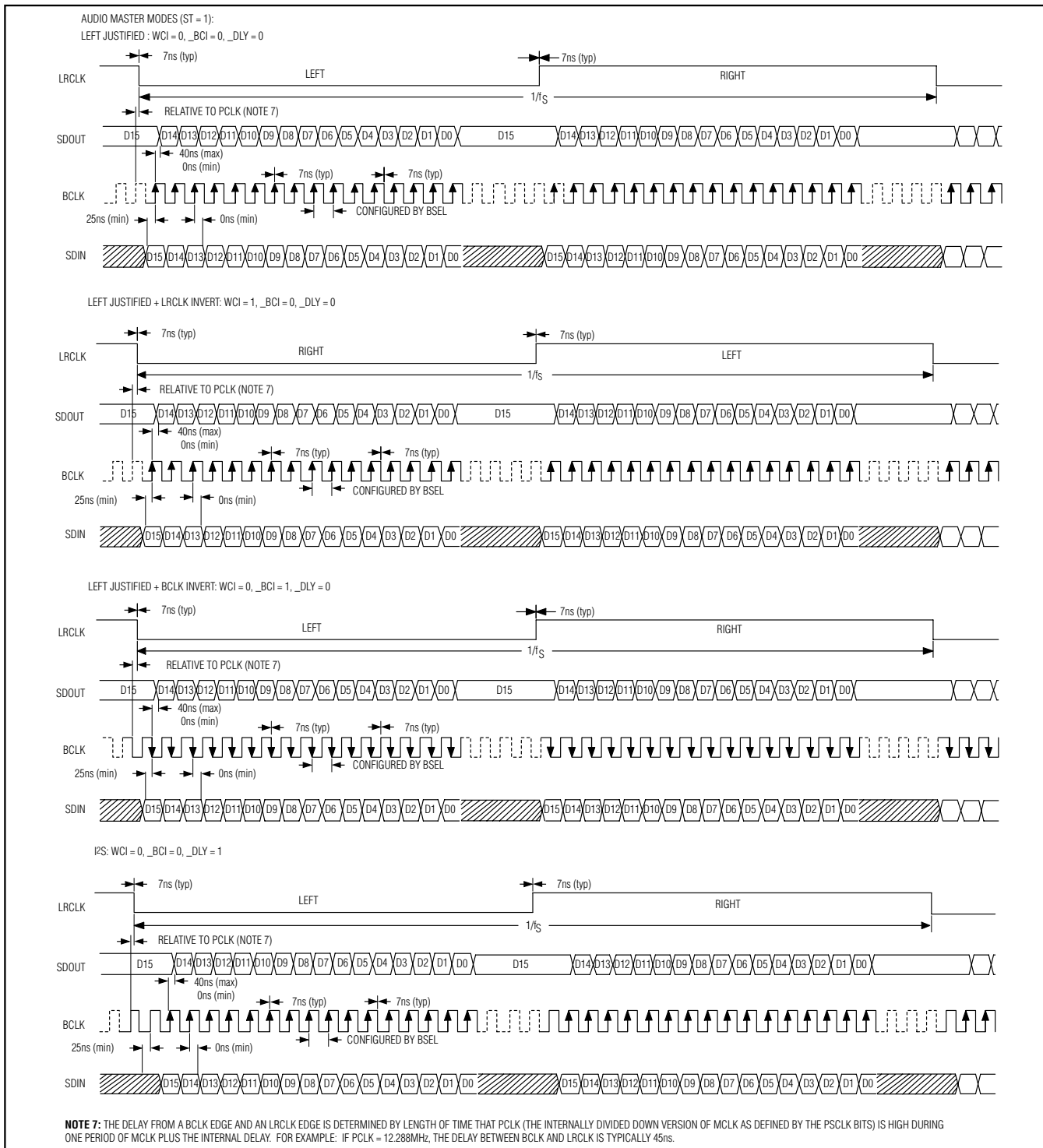

Figure 1. Digital Audio Interface Audio Master Mode Examples

# MAX9860

## 16-Bit Mono Audio Voice Codec

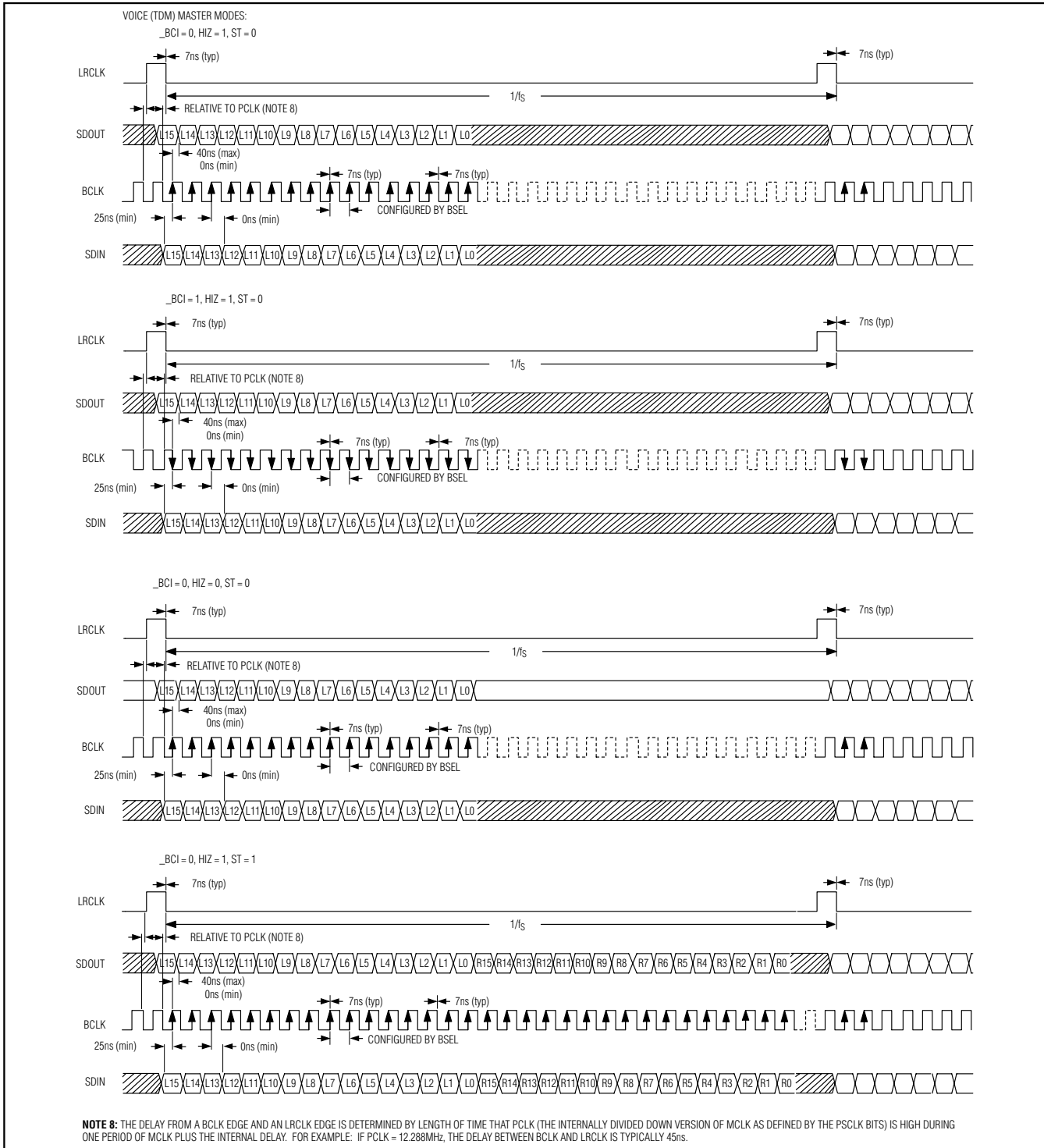

Figure 2. Digital Audio Interface Voice Master Mode Examples

## 16-Bit Mono Audio Voice Codec

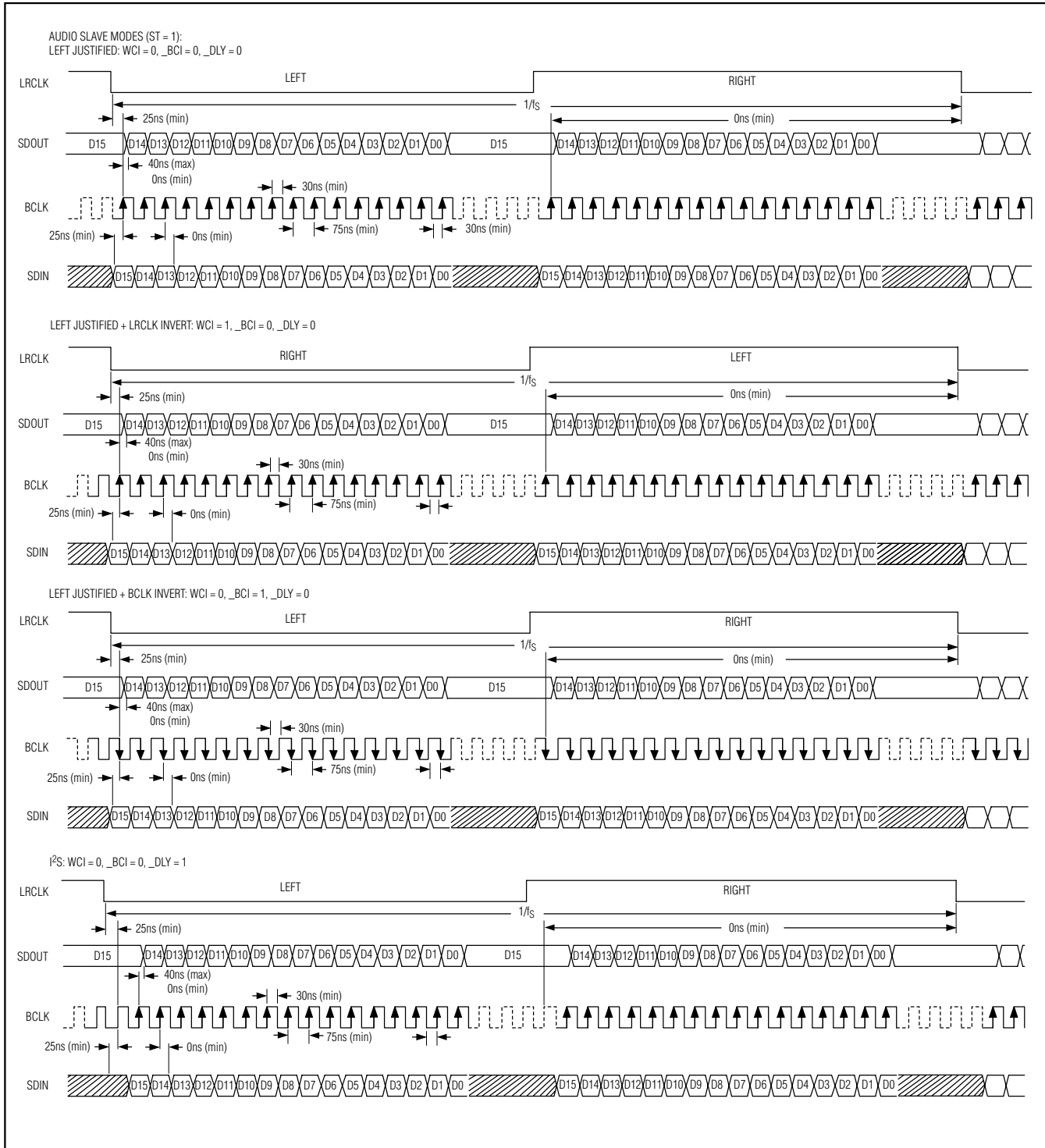

Figure 3. Digital Audio Interface Audio Slave Mode Examples

# MAX9860

## 16-Bit Mono Audio Voice Codec

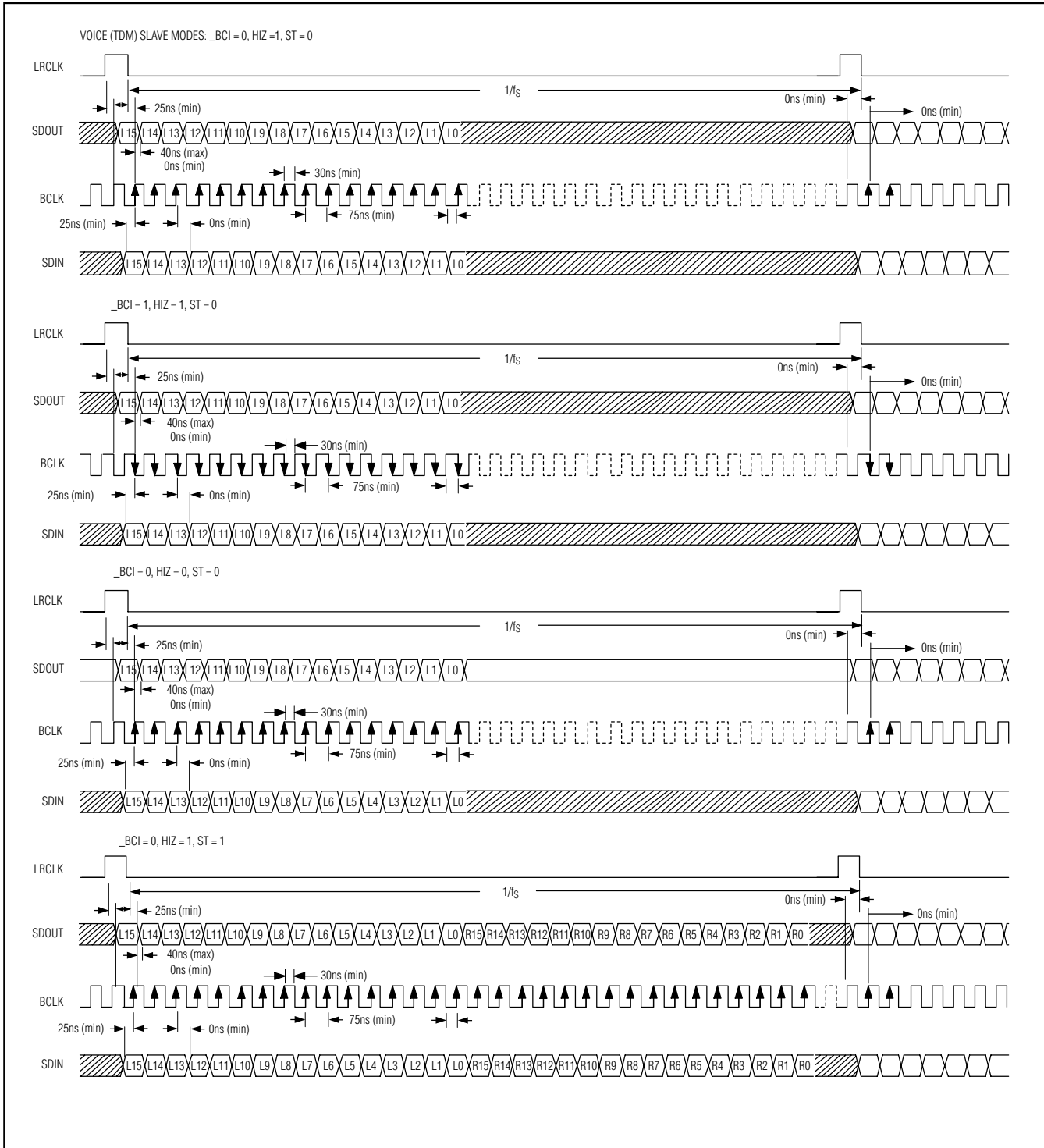

Figure 4. Digital Audio Interface Voice Slave Mode Examples



# MAX9860

## 16-Bit Mono Audio Voice Codec

### **Digital Filtering**

The MAX9860 incorporates selectable highpass and notch filters for both the playback and record paths. Each filter is valid for a specific sample rate.

**Table 6. Digital Filter Registers**

REGISTER ADDRESS	B7	B6	B5	B4	B3	B2	B1	B0
0x08	AVFLT				DVFLT			

BITS	FUNCTION
<b>AVFLT</b>	ADC Voice Filter Frequency Select. See Table 7.
<b>DVFLT</b>	DAC Voice Filter Frequency Select. See Table 7.

**Table 7. Digital Filters**

CODE	FILTER TYPE	SAMPLE RATE	DESCRIPTION
0x0	—	—	Disabled
0x1	Elliptical	16kHz	Elliptical highpass with 217Hz notch
0x2	Butterworth	16kHz	500Hz Butterworth highpass
0x3	Elliptical	8kHz	Elliptical highpass with 217Hz notch
0x4	Butterworth	8kHz	500Hz Butterworth highpass
0x5	Butterworth	48kHz	200Hz Butterworth highpass
0x6 to 0xF	—	—	Reserved

# MAX9860

## 16-Bit Mono Audio Voice Codec

### Digital Level Control

The MAX9860 includes digital gain adjustment for the playback and record paths. Independent gain

adjustment is provided for the two record channels. Sidetone gain adjustment is also provided to set the sidetone level relative to the playback level.

**Table 8. Digital Level Control Registers**

REGISTER ADDRESS	B7	B6	B5	B4	B3	B2	B1	B0
0x09	DVA							
0x0A	ADCRL				ADCLL			
0x0B	0	DVG			DVST			

BITS	FUNCTION					
DVA	DAC Level Adjust Adjusts the digital audio level before being converted by the DAC. The least significant bit of DVA is always 0.					
	<b>CODE</b>	<b>GAIN</b>	<b>CODE</b>	<b>GAIN</b>	<b>CODE</b>	<b>GAIN</b>
	0x00	+3	0x40	-29	0x80	-61
	0x02	+2	0x42	-30	0x82	-62
	0x04	+1	0x44	-31	0x84	-63
	0x06	0	0x46	-32	0x86	-64
	0x08	-1	0x48	-33	0x88	-65
	0x0A	-2	0x4A	-34	0x8A	-66
	0x0C	-3	0x4C	-35	0x8C	-67
	0x0E	-4	0x4E	-36	0x8E	-68
	0x10	-5	0x50	-37	0x90	-69
	0x12	-6	0x52	-38	0x92	-70
	0x14	-7	0x54	-39	0x94	-71
	0x16	-8	0x56	-40	0x96	-72
	0x18	-9	0x58	-41	0x98	-73
	0x1A	-10	0x5A	-42	0x9A	-74
	0x1C	-11	0x5C	-43	0x9C	-75
	0x1E	-12	0x5E	-44	0x9E	-76
	0x20	-13	0x60	-45	0xA0	-77
	0x22	-14	0x62	-46	0xA2	-78
	0x24	-15	0x64	-47	0xA4	-79
	0x26	-16	0x66	-48	0xA6	-80
	0x28	-17	0x68	-49	0xA8	-81
	0x2A	-18	0x6A	-50	0xAA	-82
	0x2C	-19	0x6C	-51	0xAC	-83
	0x2E	-20	0x6E	-52	0xAE	-84
	0x30	-21	0x70	-53	0xB0	-85
	0x32	-22	0x72	-54	0xB2	-86
	0x34	-23	0x74	-55	0xB4	-87
	0x36	-24	0x76	-56	0xB6	-88
0x38	-25	0x78	-57	0xB8	-89	
0x3A	-26	0x7A	-58	0xBA	-90	
0x3C	-27	0x7C	-59	≥ 0xBC	MUTE	
0x3E	-28	0x7E	-60	—	—	

## 16-Bit Mono Audio Voice Codec

**Table 8. Digital Level Control Registers (continued)**

BITS	FUNCTION			
ADCRL/ADCLL	<b>Left and Right ADC Output Level</b> Adjusts the digital audio level output by the ADCs.			
	<b>CODE</b>	<b>GAIN</b>		
	0x0	+3		
	0x1	+2		
	0x2	+1		
	0x3	0		
	0x4	-1		
	0x5	-2		
	0x6	-3		
	0x7	-4		
	0x8	-5		
	0x9	-6		
	0xA	-7		
	0xB	-8		
	0xC	-8		
	0xD	-10		
0xE	-11			
0xF	-12			
DVG	<b>DAC Gain</b> The gain set by DVG adds to the level set by DVA.			
	<b>CODE</b>	<b>GAIN</b>		
	00	0		
	01	+6		
	10	+12		
	11	+18		
DVST	<b>Sidetone</b> Sets the level of left ADC output mixed into the DAC.			
	<b>CODE</b>	<b>GAIN</b>	<b>CODE</b>	<b>GAIN</b>
	0x00	Disabled	0x10	-30
	0x01	0	0x11	-32
	0x02	-2	0x12	-34
	0x03	-4	0x13	-36
	0x04	-6	0x14	-38
	0x05	-8	0x15	-40
	0x06	-10	0x16	-42
	0x07	-12	0x17	-44
	0x08	-14	0x18	-46
	0x09	-16	0x19	-48
	0x0A	-18	0x1A	-50
	0x0B	-20	0x1B	-52
	0x0C	-22	0x1C	-54
	0x0D	-24	0x1D	-56
	0x0E	-26	0x1E	-58
0x0F	-28	0x1F	-60	

# MAX9860

## 16-Bit Mono Audio Voice Codec

### Microphone Inputs

The MAX9860 provides two differential microphone inputs and a low-noise 1.55V microphone bias for powering the microphones. In typical applications, the left microphone is used to record a voice signal and the right microphone is used to record a background noise signal. In applications that require only one microphone, use the left microphone input and disable the right ADC. The microphone signals are amplified by two stages of

gain and then routed to the ADCs. The first stage offers selectable 0dB, 20dB, or 30dB settings. The second stage is a programmable gain amplifier (PGA) adjustable from 0dB to 20dB in 1dB steps. Zero-crossing detection is included on the PGA to minimize zipper noise while making gain changes. See Figure 5 for a detailed diagram of the microphone input structure.

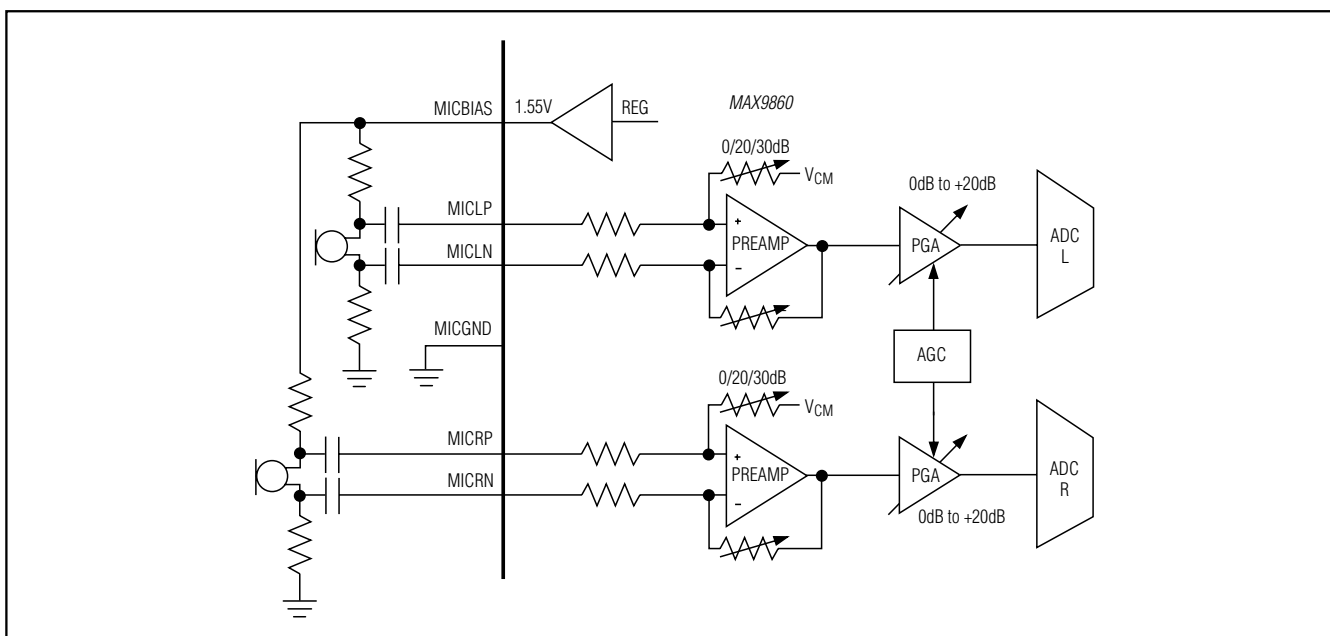

Figure 5. Microphone Input Block Diagram

# MAX9860

## 16-Bit Mono Audio Voice Codec

**Table 9. Microphone Input Register**

REGISTER ADDRESS	B7	B6	B5	B4	B3	B2	B1	B0
0x0C	0	PAM			PGAM			

BITS	FUNCTION			
PAM	<b>Left and Right Microphone Preamp Gain</b>			
	<b>CODE</b>	<b>GAIN (dB)</b>		
	00	Disabled		
	01	0		
	10	+20		
	11	+30		
	<b>Note:</b> Selecting 00 disables the microphone inputs and microphone bias automatically.			
PGAM	<b>Left and Right Microphone PGA</b>			
	<b>CODE</b>	<b>GAIN (dB)</b>	<b>CODE</b>	<b>GAIN (dB)</b>
	0x00	+20	0x0B	+9
	0x01	+19	0x0C	+8
	0x02	+18	0x0D	+7
	0x03	+17	0x0E	+6
	0x04	+16	0x0F	+5
	0x05	+15	0x10	+4
	0x06	+14	0x11	+3
	0x07	+13	0x12	+2
	0x08	+12	0x13	+1
	0x09	+11	≥ 0x14	0
	0x0A	+10	—	—
	<b>Note:</b> When AGC is enabled, the AGC controller overrides these settings.			

# MAX9860

## 16-Bit Mono Audio Voice Codec

### Automatic Gain Control (AGC) and Noise Gate

The MAX9860 includes AGC on both microphone inputs. AGC is enabled by setting the hold time through AGCHLD. AGC dynamically controls the analog PGA microphone input gain to hold the level constant over a 20dB input range, enhancing the voice path operation for various use conditions. When AGC is enabled, it monitors the signal level at the output of the ADC and then makes gain adjustments by controlling the analog microphone PGA. When AGC is enabled, PGAM is not user programmable.

Since AGC increases the level of all signals below a user-defined threshold, the noise floor effectively is increased by 20dB. To counteract this, a noise gate is included to reduce the gain at low levels. Unlike typical noise gates that completely silence the output below a threshold, the noise gate in the MAX9860 reduces the gain for signals below the defined level. As the signal level becomes further below the threshold, the gain is further reduced. The Automatic Gain Control Thresholds and Noise Gate Thresholds graphs in the *Typical Operating Characteristics* show the resulting steady-state transfer curves when AGC and the noise gate are enabled.

**Table 10. AGC and Noise Gate Registers**

REGISTER ADDRESS	B7	B6	B5	B4	B3	B2	B1	B0
0x0E	AGCSRC	AGCRLS			AGCATK		AGCHLD	
0x0F	ANTH				AGCTH			

BITS	FUNCTION	
AGCSRC	<b>AGC/Noise Gate Signal Source Select</b> 0 = The left ADC output is used by the AGC and noise gate. 1 = The sum of the left and right ADC outputs is used by the AGC and noise gate.	
AGCRLS	<b>AGC Release Time</b> Time taken by the AGC circuit to increase the gain from minimum to maximum.	
	<b>CODE</b>	<b>TIME</b>
	000	78ms
	001	156ms
	010	312ms
	011	625ms
	100	1.25s
	101	2.5s
	110	5s
111	10s	
AGCATK	<b>AGC Attack Time</b> The time constant of the AGC gain reduction curve.	
	<b>CODE</b>	<b>TIME (ms)</b>
	00	3
	01	12
	10	50
	11	200
AGCHLD	<b>AGC Hold Time</b> Time the AGC circuit waits before beginning to increase gain when a signal below the threshold is detected.	
	<b>CODE</b>	<b>TIME (ms)</b>
	00	AGC disabled
	01	50
	10	100
	11	400

## 16-Bit Mono Audio Voice Codec

**Table 10. AGC and Noise Gate Registers (continued)**

BITS	FUNCTION			
ANTH	<p><b>Noise Gate Threshold</b>                      The signal level at which the noise gate begins reducing the gain. When the signal level is above the threshold the noise gate has no effect. When the signal level is below the threshold, the noise gate decreases the gain by 1dB for every 2dB the signal is below the threshold.</p> <p>The noise gate can be enabled independently from AGC. When AGC is enabled, PGAM must be set to +20dB (indicating a small signal is present) for the noise gate to attenuate.</p> <p>For microphone signals, use the noise gate and AGC simultaneously with ANTH set between -16dB and -28dB.</p>			
	<b>ANTH[3:0]</b>	<b>LEVEL (dBFS)</b>	<b>ANTH[3:0]</b>	<b>LEVEL (dBFS)</b>
	0x0	Disabled	0x8	-44
	0x1	-72	0x9	-40
	0x2	-68	0xA	-36
	0x3	-64	0xB	-32
	0x4	-60	0xC	-28
	0x5	-56	0xD	-24
	0x6	-52	0xE	-20
0x7	-48	0xF	-16	
AGCTH	<p><b>AGC Signal Threshold</b>                      The target output signal level. When the signal level is below the threshold, the AGC increases the gain. The signal level is measured after ADCRL and ADCLL are applied to the ADC output.</p>			
	<b>ANTH[3:0]</b>	<b>LEVEL (dBFS)</b>	<b>ANTH[3:0]</b>	<b>LEVEL (dBFS)</b>
	0x0	-3	0x8	-11
	0x1	-4	0x9	-12
	0x2	-5	0xA	-13
	0x3	-6	0xB	-14
	0x4	-7	0xC	-15
	0x5	-8	0xD	-16
	0x6	-9	0xE	-17
0x7	-10	0xF	-18	

# MAX9860

## 16-Bit Mono Audio Voice Codec

### Power Management

The MAX9860 includes complete power management control to minimize power usage. The DAC and both

ADCs can be independently enabled so that only the required circuitry is active.

**Table 11. Power Management Register**

REGISTER ADDRESS	B7	B6	B5	B4	B3	B2	B1	B0
0x10	$\overline{\text{SHDN}}$	0	0	0	DACEN	0	ADCLEN	ADCREN

BITS	FUNCTION
$\overline{\text{SHDN}}$	<b>Active-Low Software Shutdown</b> 0 = MAX9860 is in full shutdown. 1 = MAX9860 is powered on.  When $\overline{\text{SHDN}} = 0$ . All register settings are preserved and the I <sup>2</sup> C interface remains active.
DACEN	<b>DAC Enable</b> 0 = DAC disabled. 1 = DAC enabled.
ADCLEN/ADCREN	<b>ADC Left/Right Enable</b> 0 = Left/right ADC disabled. 1 = Left/right ADC enabled.  The left ADC must be enabled when using the right ADC.

### Revision Code

The MAX9860 includes a revision code to allow easy identification of the device revision. The current revision code is 0x40.

**Table 12. Revision Code Register**

ADDR	B7	B6	B5	B4	B3	B2	B1	B0
0xFF	REV							

### I<sup>2</sup>C Serial Interface

The MAX9860 features an I<sup>2</sup>C/SMBus™-compatible, 2-wire serial interface consisting of a serial-data line (SDA) and a serial-clock line (SCL). SDA and SCL facilitate communication between the MAX9860 and the master at clock rates up to 400kHz. Figure 6 shows the 2-wire interface timing diagram. The master generates SCL and initiates data transfer on the bus. The master device writes data to the MAX9860 by transmitting the proper slave address followed by the register address and then the data word. Each transmit sequence is framed by a START (S) or REPEATED START (Sr) condition and a STOP (P) condition. Each word transmitted to the MAX9860 is 8 bits long and is followed by an acknowledge clock pulse. A master reading data from the MAX9860 transmits the proper slave address followed by a series of nine SCL pulses. The MAX9860

transmits data on SDA in sync with the master-generated SCL pulses. The master acknowledges receipt of each byte of data. Each read sequence is framed by a START or REPEATED START condition, a not acknowledge, and a STOP condition. SDA operates as both an input and an open-drain output. A pullup resistor, typically greater than 500Ω, is required on SDA. SCL operates only as an input. A pullup resistor, typically greater than 500Ω, is required on SCL if there are multiple masters on the bus, or if the single master has an open-drain SCL output. Series resistors in line with SDA and SCL are optional. Series resistors protect the digital inputs of the MAX9860 from high voltage spikes on the bus lines, and minimize crosstalk and undershoot of the bus signals.

*SMBus is a trademark of Intel Corp.*



## 16-Bit Mono Audio Voice Codec

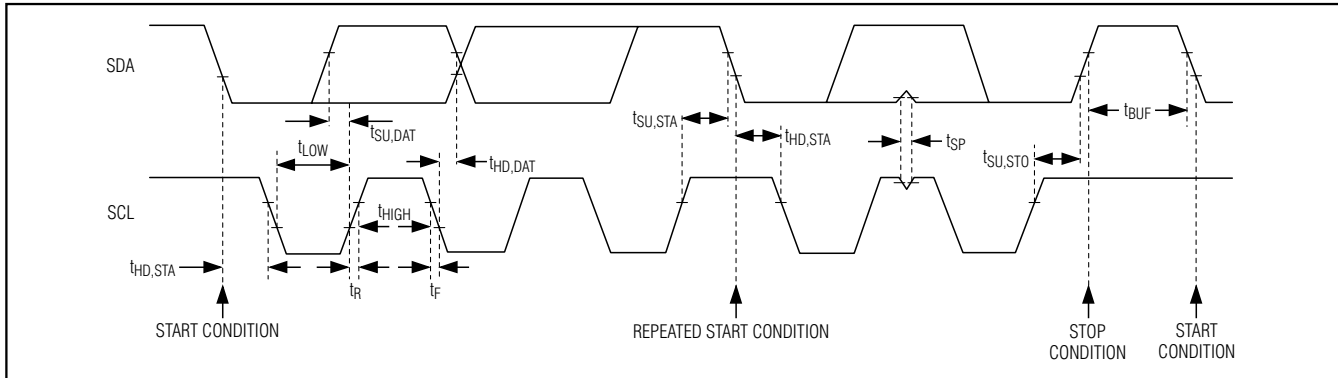

Figure 6. 2-Wire Interface Timing Diagram

### Bit Transfer

One data bit is transferred during each SCL cycle. The data on SDA must remain stable during the high period of the SCL pulse. Changes in SDA while SCL is high are control signals (see the *START and STOP Conditions* section).

### START and STOP Conditions

SDA and SCL idle high when the bus is not in use. A master initiates communication by issuing a START (S) condition. A START condition is a high-to-low transition on SDA with SCL high. A STOP (P) condition is a low-to-high transition on SDA while SCL is high (Figure 7). A START condition from the master signals the beginning of a transmission to the MAX9860. The master terminates transmission, and frees the bus, by issuing a STOP condition. The bus remains active if a REPEATED START (Sr) condition is generated instead of a STOP condition.

### Early STOP Conditions

The MAX9860 recognizes a STOP condition at any point during data transmission except if the STOP condition occurs in the same high pulse as a START condition. For proper operation, do not send a STOP condition during the same SCL high pulse as the START condition.

### Slave Address

The slave address is defined as the seven most significant bits (MSBs) followed by the read/write bit. For the MAX9860, the seven most significant bits are 0010000. Setting the read/write bit to 1 (slave address = 0x21) configures the MAX9860 for read mode. Setting the read/write bit to 0 (slave address = 0x20) configures the MAX9860 for write mode. The address is the first byte of information sent to the MAX9860 after the START condition.

### Acknowledge

The acknowledge bit (ACK) is a clocked 9th bit that the MAX9860 uses to handshake receipt each byte of data when in write mode (see Figure 8). The MAX9860 pulls down SDA during the entire master-generated 9th clock pulse if the previous byte is successfully received. Monitoring ACK allows for detection of unsuccessful data transfers. An unsuccessful data transfer occurs if a receiving device is busy or if a system fault has occurred. In the event of an unsuccessful data transfer, the bus master retries communication. The master pulls down SDA during the 9th clock cycle to acknowledge receipt of data when the MAX9860 is in read mode. An acknowledge is sent by the master after each read byte to allow data transfer to continue. A not acknowledge is sent when the master reads the final byte of data from the MAX9860, followed by a STOP condition.

### Write Data Format

A write to the MAX9860 includes transmission of a START condition, the slave address with the R/W bit set to 0, one byte of data to configure the internal register address pointer, one or more bytes of data, and a STOP condition. Figure 9 illustrates the proper frame format for writing one byte of data to the MAX9860. Figure 10 illustrates the frame format for writing n bytes of data to the MAX9860.

The slave address with the R/W bit set to 0 indicates that the master intends to write data to the MAX9860. The MAX9860 acknowledges receipt of the address byte during the master-generated 9th SCL pulse.

The second byte transmitted from the master configures the MAX9860's internal register address pointer. The pointer tells the MAX9860 where to write the next byte of data. An acknowledge pulse is sent by the MAX9860 upon receipt of the address pointer data.

# MAX9860

## 16-Bit Mono Audio Voice Codec

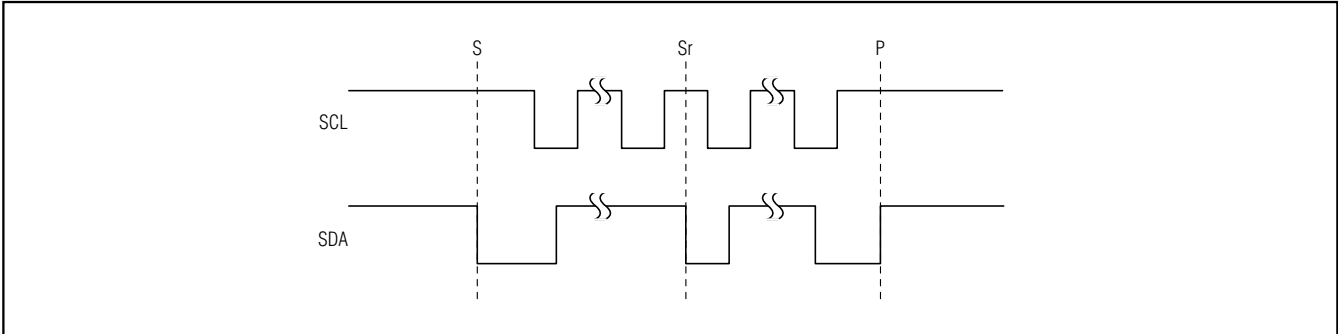

Figure 7. START (S), STOP (P), and REPEATED START (Sr) Conditions

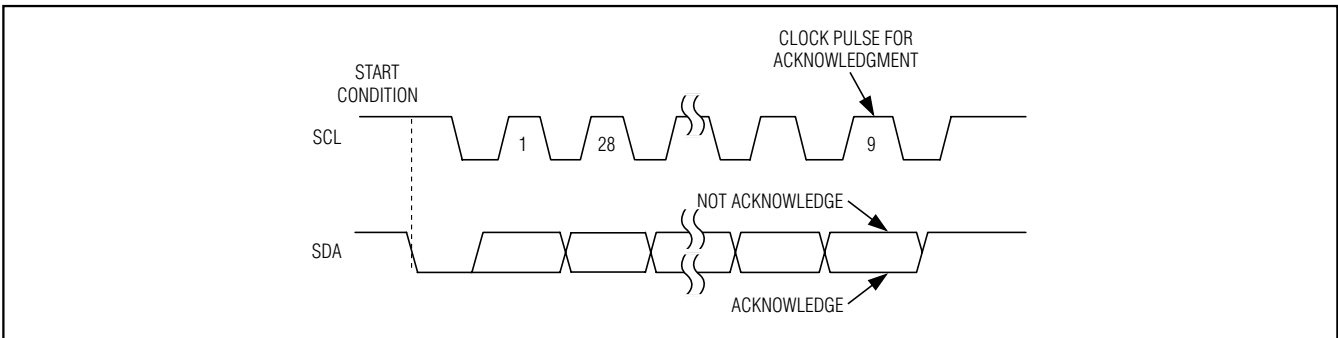

Figure 8. Acknowledge

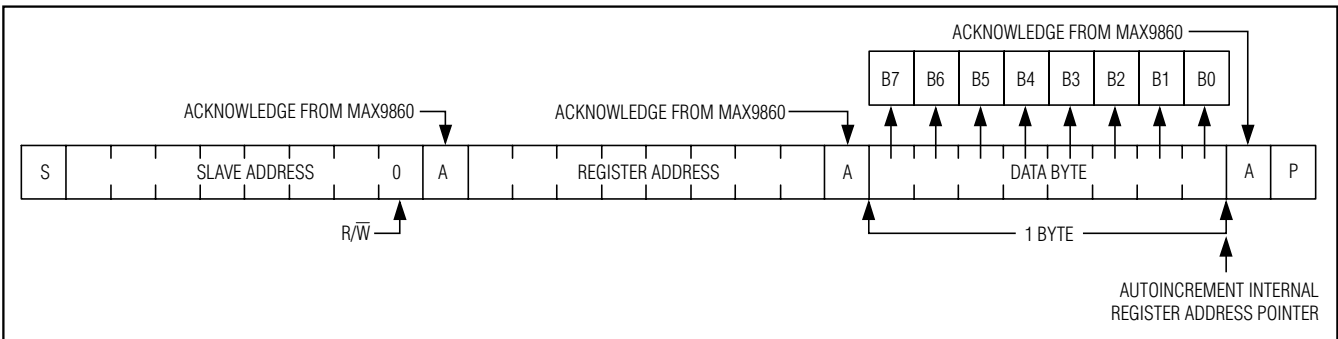

Figure 9. Writing One Byte of Data to the MAX9860

The third byte sent to the MAX9860 contains the data that is written to the chosen register. An acknowledge pulse from the MAX9860 signals receipt of the data byte. The address pointer autoincrements to the next register address after each received data byte. This autoincrement feature allows a master to write to sequential registers within one continuous frame. Figure 10 illustrates how to write to multiple registers with one frame. The master signals the end of transmission by issuing a STOP condition. Register addresses greater than 0x10 are reserved. Do not write to these addresses.

### Read Data Format

Send the slave address with the  $R/\bar{W}$  bit set to 1 to initiate a read operation. The MAX9860 acknowledges receipt of its slave address by pulling SDA low during the 9th SCL clock pulse. A START command followed by a read command resets the address pointer to register 0x00.

The first byte transmitted from the MAX9860 is the contents of register 0x00. Transmitted data is valid on the rising edge of SCL. The address pointer autoincrements after each read data byte. This autoincrement

# MAX9860

## 16-Bit Mono Audio Voice Codec

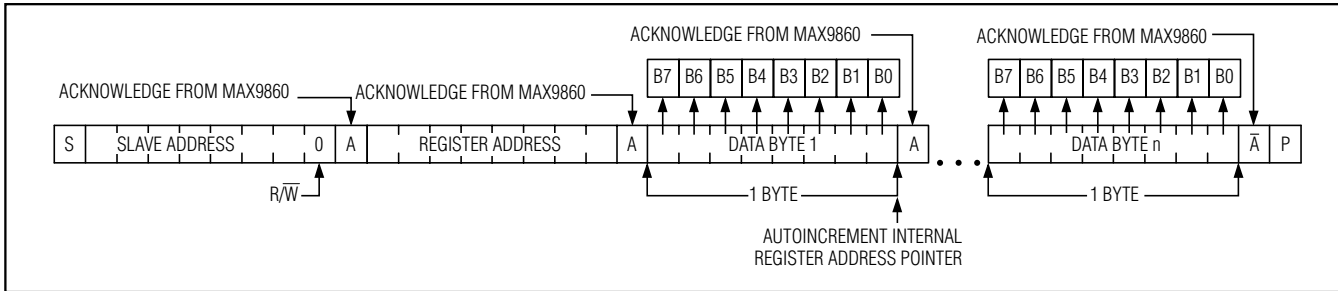

Figure 10. Writing N Bytes of Data to the MAX9860

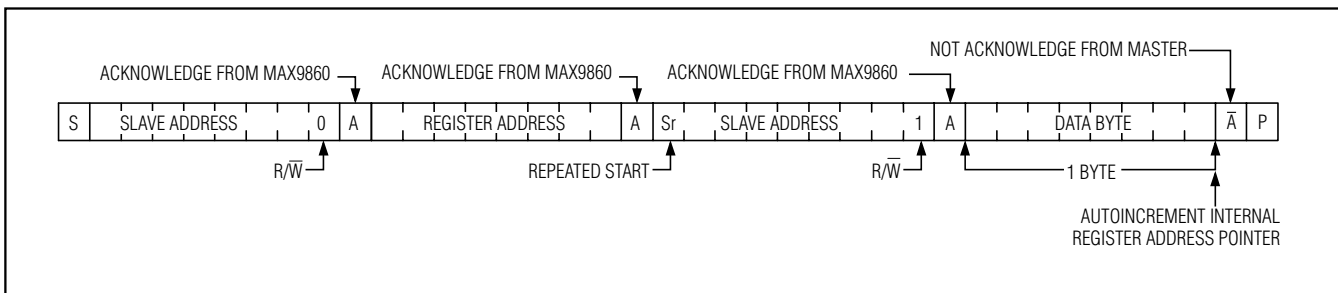

Figure 11. Reading One Byte of Data from the MAX9860

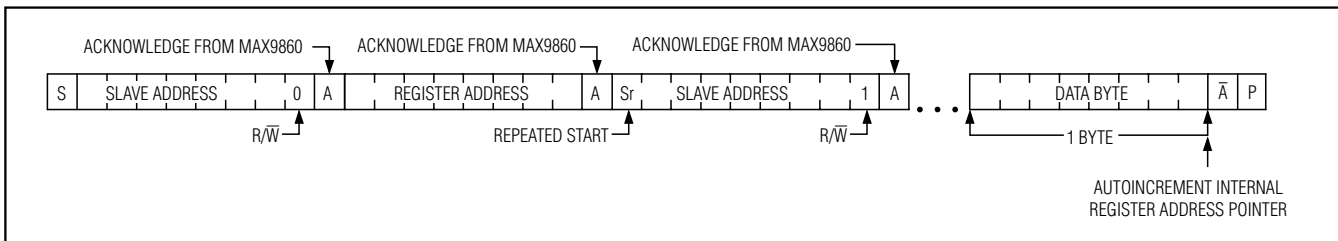

Figure 12. Reading N Bytes of Data from the MAX9860

feature allows all registers to be read sequentially within one continuous frame. A STOP (P) condition can be issued after any number of read data bytes. If a STOP condition is issued followed by another read operation, the first data byte to be read is from register 0x00.

The address pointer can be preset to a specific register before a read command is issued. The master presets the address pointer by first sending the MAX9860's slave address with the R/W bit set to 0 followed by the register address. A REPEATED START (Sr) condition is then sent followed by the slave address with the R/W bit set to 1. The MAX9860 then transmits the contents of the specified register. The address pointer autoincrements after transmitting the first byte.

The master acknowledges receipt of each read byte during the acknowledge clock pulse. The master must acknowledge all correctly received bytes except the last byte. The final byte must be followed by a not acknowledge from the master and then a STOP condition. Figure 11 illustrates the frame format for reading one byte from the MAX9860. Figure 12 illustrates the frame format for reading multiple bytes from the MAX9860.

# MAX9860

## 16-Bit Mono Audio Voice Codec

### Pin Configuration

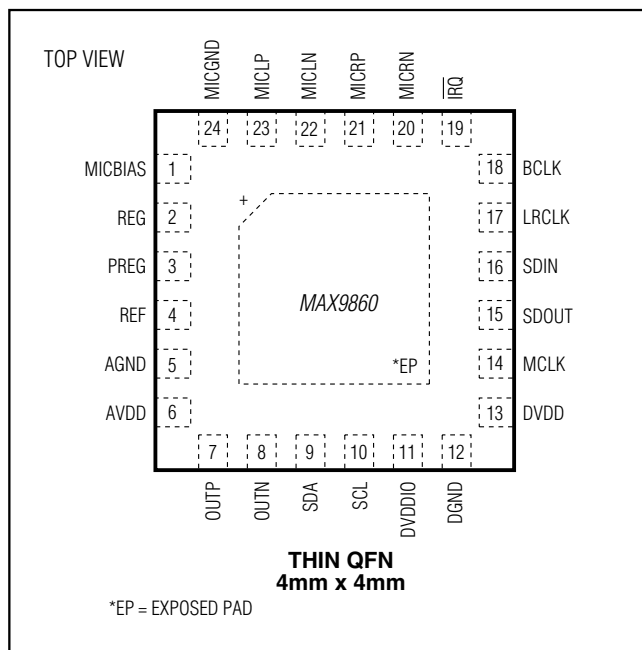

Route microphone signals from the microphone to the MAX9860 as a differential pair, ensuring that the positive and negative signals follow the same path as closely as possible with equal trace length. When using single-ended microphones or other single-ended audio sources, AC ground the negative microphone input signal as near to the audio source as possible and then treat the positive and negative traces as differential pairs.

The MAX9860 thin QFN package features an exposed thermal pad on its underside. This pad lowers the package's thermal resistance by providing a direct heat conduction path from the die to the PCB. Connect the exposed thermal pad to AGND.

An evaluation kit (EV kit) is available to provide an example layout for the MAX9860. The EV kit allows quick setup of the MAX9860 and includes easy-to-use software allowing all internal registers to be controlled.

### Applications Information

Proper layout and grounding are essential for optimum performance. When designing a PCB for the MAX9860, partition the circuitry so that the analog sections of the MAX9860 are separated from the digital sections. This ensures that the analog audio traces do not need to be routed near digital traces.

Use a large continuous ground plane on a dedicated layer of the PCB to minimize loop areas. Connect AGND, DGND, and MICGND directly to the ground plane using the shortest trace length possible. Proper grounding improves audio performance, minimizes crosstalk between channels, and prevents any digital noise from coupling into the analog audio signal.

Ground the bypass capacitors on REG, PREG, and REF directly to the ground plane with minimum trace length. Also be sure to minimize the path length to AGND and MICGND. Bypass AVDD directly to AGND. Bypass MICBIAS directly to MICGND.

Connect all digital I/O termination to the ground plane with minimum path length to DGND. Bypass DVDD and DVDDIO directly to DGND.



# MAX9860

## 16-Bit Mono Audio Voice Codec

### Revision History

REVISION NUMBER	REVISION DATE	DESCRIPTION	PAGES CHANGED
0	10/08	Initial release	—
1	9/09	Corrected error in Table 11	32
2	2/12	Removed V <sub>OS</sub> typical spec and updated max spec	5



Maxim Integrated cannot assume responsibility for use of any circuitry other than circuitry entirely embodied in a Maxim Integrated product. No circuit patent licenses are implied. Maxim Integrated reserves the right to change the circuitry and specifications without notice at any time. The parametric values (min and max limits) shown in the Electrical Characteristics table are guaranteed. Other parametric values quoted in this data sheet are provided for guidance.