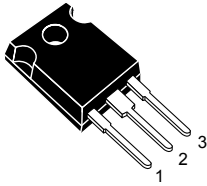
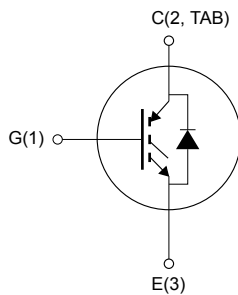


## Trench gate field-stop, 1200 V, 25 A, low-loss M series IGBT in a TO-247 package



TO-247



NG1E3C2T



## Features

- Maximum junction temperature:  $T_J = 175\text{ °C}$
- 10  $\mu\text{s}$  of short-circuit withstand time
- Low  $V_{CE(sat)} = 1.85\text{ V (typ.) @ } I_C = 25\text{ A}$
- Tight parameter distribution
- Positive  $V_{CE(sat)}$  temperature coefficient
- Low thermal resistance
- Soft- and fast-recovery antiparallel diode

## Applications

- Industrial drives
- UPS
- Solar
- Welding

## Description

This device is an IGBT developed using an advanced proprietary trench gate field-stop structure. The device is part of the M series IGBTs, which represent an optimal balance between inverter system performance and efficiency where the low-loss and the short-circuit functionality is essential. Furthermore, the positive  $V_{CE(sat)}$  temperature coefficient and the tight parameter distribution result in safer paralleling operation.

## Product status link

[STGW25M120DF3](#)

## Product summary

Order code	STGW25M120DF3
Marking	G25M120DF3
Package	TO-247
Packing	Tube

# 1 Electrical ratings

**Table 1. Absolute maximum ratings**

Symbol	Parameter	Value	Unit
$V_{CES}$	Collector-emitter voltage ( $V_{GE} = 0$ V)	1200	V
$I_C$	Continuous collector current at $T_C = 25$ °C	50	A
	Continuous collector current at $T_C = 100$ °C	25	A
$I_{CP}^{(1)}$	Pulsed collector current	100	A
$V_{GE}$	Gate-emitter voltage	±20	V
	Transient gate-emitter voltage	±30	V
$I_F$	Continuous forward current at $T_C = 25$ °C	50	A
	Continuous forward current at $T_C = 100$ °C	25	A
$I_{FP}^{(1)}$	Pulsed forward current	100	A
$P_{TOT}$	Total power dissipation at $T_C = 25$ °C	375	W
$T_{STG}$	Storage temperature range	-55 to 150	°C
$T_J$	Operating junction temperature range	-55 to 175	°C

1. Pulse width is limited by maximum junction temperature.

**Table 2. Thermal data**

Symbol	Parameter	Value	Unit
$R_{thJC}$	Thermal resistance junction-case IGBT	0.4	°C/W
	Thermal resistance junction-case diode	0.96	°C/W
$R_{thJA}$	Thermal resistance junction-ambient	50	°C/W

## 2 Electrical characteristics

$T_J = 25\text{ °C}$  unless otherwise specified

**Table 3. Static characteristics**

Symbol	Parameter	Test conditions	Min.	Typ.	Max.	Unit
$V_{(BR)CES}$	Collector-emitter breakdown voltage	$V_{GE} = 0\text{ V}, I_C = 2\text{ mA}$	1200			V
$V_{CE(sat)}$	Collector-emitter saturation voltage	$V_{GE} = 15\text{ V}, I_C = 25\text{ A}$		1.85	2.3	V
		$V_{GE} = 15\text{ V}, I_C = 25\text{ A}, T_J = 125\text{ °C}$		2.1		
		$V_{GE} = 15\text{ V}, I_C = 25\text{ A}, T_J = 175\text{ °C}$		2.2		
$V_F$	Forward on-voltage	$I_F = 25\text{ A}$		2.95	4.1	V
		$I_F = 25\text{ A}, T_J = 125\text{ °C}$		2.25		
		$I_F = 25\text{ A}, T_J = 175\text{ °C}$		1.9		
$V_{GE(th)}$	Gate threshold voltage	$V_{CE} = V_{GE}, I_C = 1\text{ mA}$	5	6	7	V
$I_{CES}$	Collector cut-off current	$V_{GE} = 0\text{ V}, V_{CE} = 1200\text{ V}$			25	$\mu\text{A}$
$I_{GES}$	Gate-emitter leakage current	$V_{CE} = 0\text{ V}, V_{GE} = \pm 20\text{ V}$			$\pm 250$	nA

**Table 4. Dynamic characteristics**

Symbol	Parameter	Test conditions	Min.	Typ.	Max.	Unit
$C_{ies}$	Input capacitance	$V_{CE} = 25\text{ V}, f = 1\text{ MHz}, V_{GE} = 0\text{ V}$	-	1550	-	pF
$C_{oes}$	Output capacitance		-	180	-	
$C_{res}$	Reverse transfer capacitance		-	65	-	
$Q_g$	Total gate charge	$V_{CC} = 960\text{ V}, I_C = 25\text{ A},$	-	85	-	nC
$Q_{ge}$	Gate-emitter charge	$V_{GE} = 0\text{ to }15\text{ V}$	-	11.5	-	
$Q_{gc}$	Gate-collector charge	(see <a href="#">Figure 29. Gate charge test circuit</a> )	-	45.5	-	

**Table 5. IGBT switching characteristics (inductive load)**

Symbol	Parameter	Test conditions	Min.	Typ.	Max.	Unit
$t_{d(on)}$	Turn-on delay time	$V_{CE} = 600\text{ V}$ , $I_C = 25\text{ A}$ , $V_{GE} = 15\text{ V}$ , $R_G = 15\ \Omega$ (see Figure 28. Test circuit for inductive load switching)		28	-	ns
$t_r$	Current rise time			15	-	ns
$(di/dt)_{on}$	Turn-on current slope			1370	-	A/ $\mu$ s
$t_{d(off)}$	Turn-off delay time			150	-	ns
$t_f$	Current fall time			155	-	ns
$E_{on}^{(1)}$	Turn-on switching energy			0.85	-	mJ
$E_{off}^{(2)}$	Turn-off switching energy			1.3	-	mJ
$E_{ts}$	Total switching energy			2.15	-	mJ
$t_{d(on)}$	Turn-on delay time		$V_{CE} = 600\text{ V}$ , $I_C = 25\text{ A}$ , $V_{GE} = 15\text{ V}$ , $R_G = 15\ \Omega$ , $T_J = 175\text{ }^\circ\text{C}$ (see Figure 28. Test circuit for inductive load switching)		28	-
$t_r$	Current rise time			17	-	ns
$(di/dt)_{on}$	Turn-on current slope			1270	-	A/ $\mu$ s
$t_{d(off)}$	Turn-off delay time			155	-	ns
$t_f$	Current fall time			240	-	ns
$E_{on}^{(1)}$	Turn-on switching energy			1.6	-	mJ
$E_{off}^{(2)}$	Turn-off switching energy			1.9	-	mJ
$E_{ts}$	Total switching energy			3.5	-	mJ
$t_{sc}$	Short-circuit withstand time	$V_{CC} \leq 600\text{ V}$ , $V_{GE} = 15\text{ V}$ , $T_{Jstart} \leq 150\text{ }^\circ\text{C}$		10		-

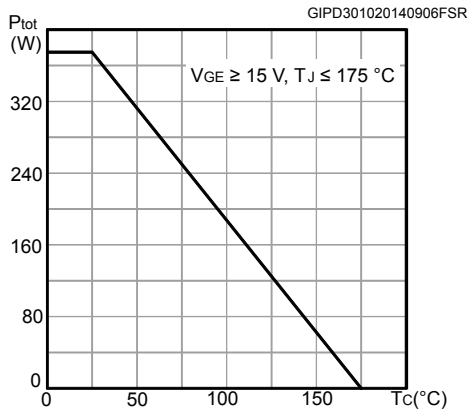
1. Including the reverse recovery of the diode
2. Including the tail of the collector current

**Table 6. Diode switching characteristics (inductive load)**

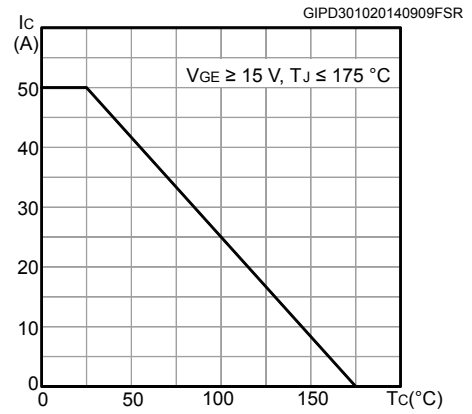
Symbol	Parameter	Test conditions	Min.	Typ.	Max.	Unit	
$t_{rr}$	Reverse recovery time	$I_F = 25\text{ A}$ , $V_R = 600\text{ V}$ , $V_{GE} = 15\text{ V}$ , $di/dt = 1000\text{ A}/\mu\text{s}$ (see Figure 28. Test circuit for inductive load switching)	-	265	-	ns	
$Q_{rr}$	Reverse recovery charge			-	1.2	-	$\mu$ C
$I_{rrm}$	Reverse recovery current			-	19	-	A
$dI_{rr}/dt$	Peak rate of fall of reverse recovery current during $t_b$			-	1090	-	A/ $\mu$ s
$E_{rr}$	Reverse recovery energy			-	0.22	-	mJ
$t_{rr}$	Reverse recovery time	$I_F = 25\text{ A}$ , $V_R = 600\text{ V}$ , $V_{GE} = 15\text{ V}$ , $T_J = 175\text{ }^\circ\text{C}$ , $di/dt = 1000\text{ A}/\mu\text{s}$ (see Figure 28. Test circuit for inductive load switching)	-	585	-	ns	
$Q_{rr}$	Reverse recovery charge			-	5	-	$\mu$ C
$I_{rrm}$	Reverse recovery current			-	30	-	A
$dI_{rr}/dt$	Peak rate of fall of reverse recovery current during $t_b$			-	270	-	A/ $\mu$ s
$E_{rr}$	Reverse recovery energy			-	0.75	-	mJ

## 2.1 Electrical characteristics (curves)

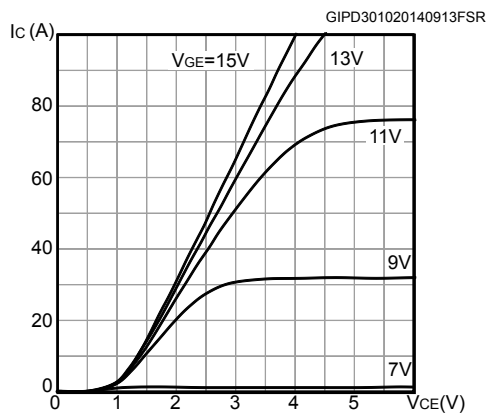
**Figure 1. Power dissipation vs case temperature**



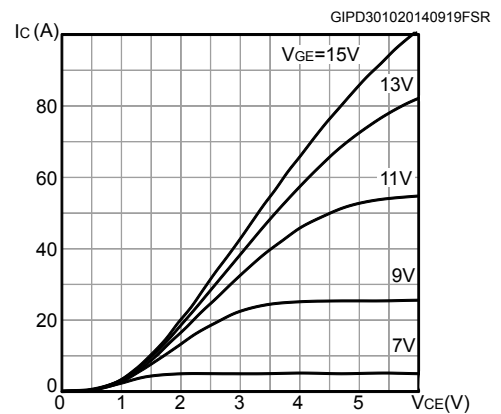
**Figure 2. Collector current vs case temperature**



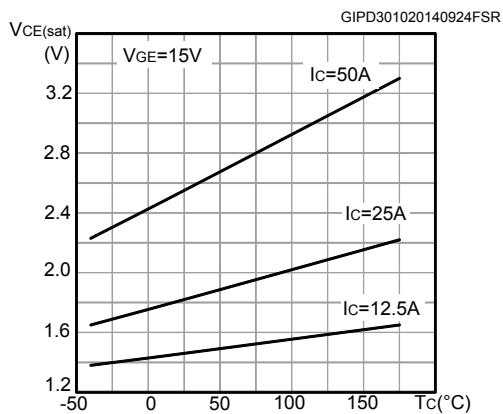
**Figure 3. Output characteristics ( $T_J = 25 \text{ }^\circ\text{C}$ )**



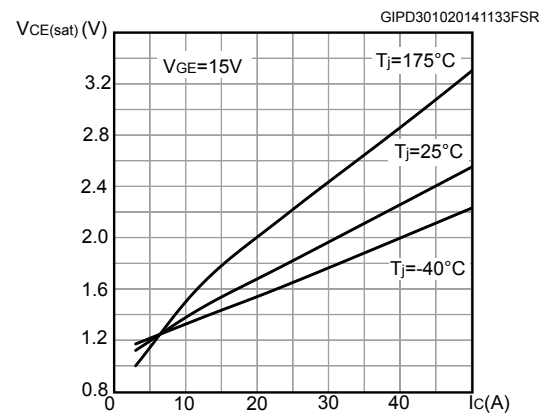
**Figure 4. Output characteristics ( $T_J = 175 \text{ }^\circ\text{C}$ )**



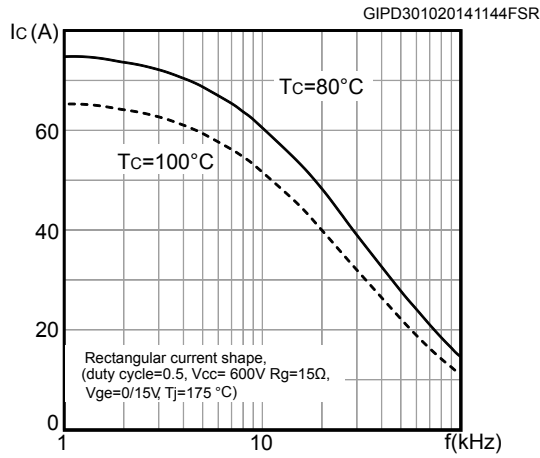
**Figure 5.  $V_{CE(sat)}$  vs junction temperature**



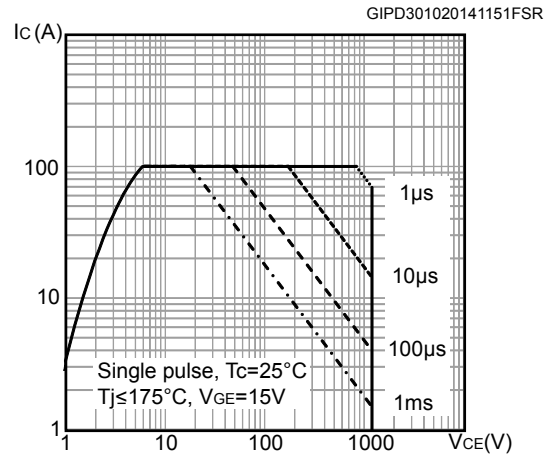
**Figure 6.  $V_{CE(sat)}$  vs collector current**



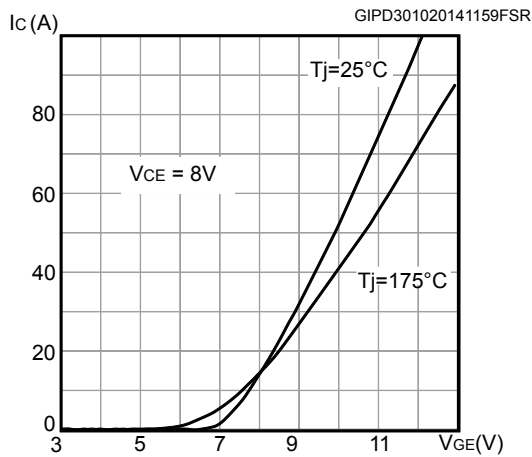
**Figure 7. Collector current vs switching frequency**



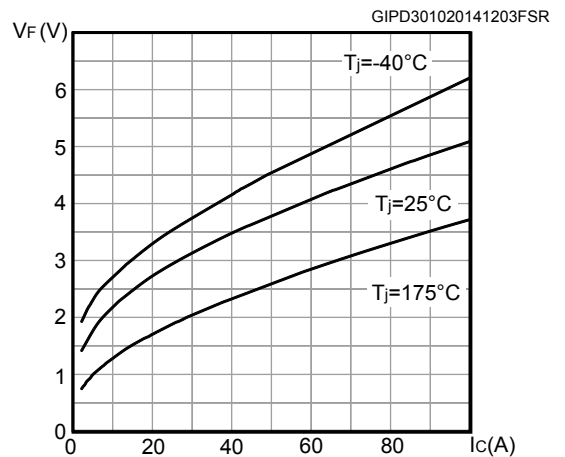
**Figure 8. Safe operating area**



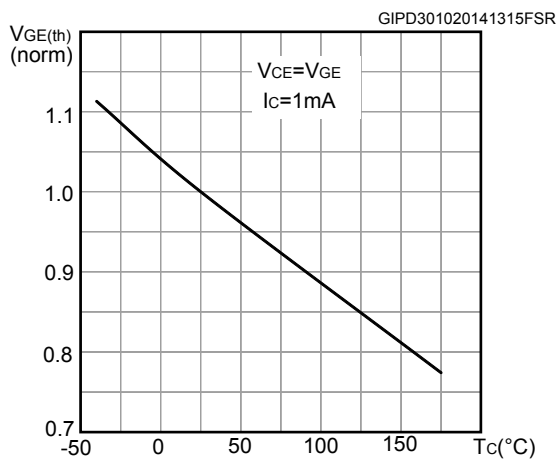
**Figure 9. Transfer characteristics**



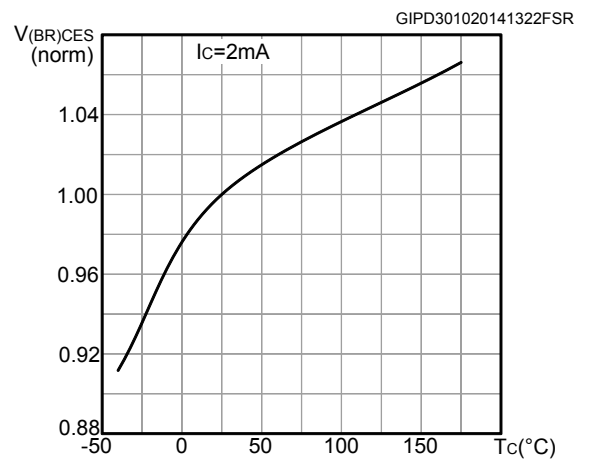
**Figure 10. Diode Vf vs forward current**



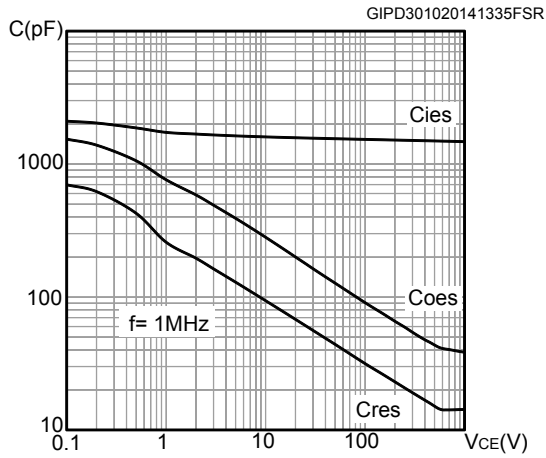
**Figure 11. Normalized VGE(th) vs junction temperature**



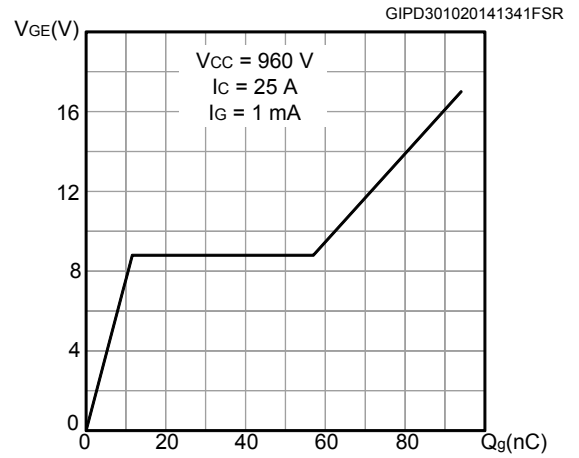
**Figure 12. Normalized V(BR)CES vs junction temperature**



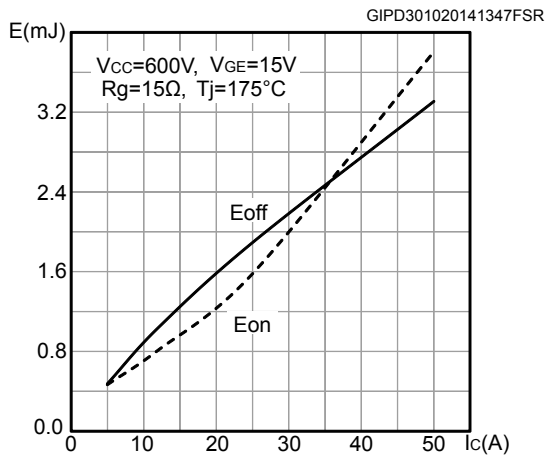
**Figure 13. Capacitance variations**



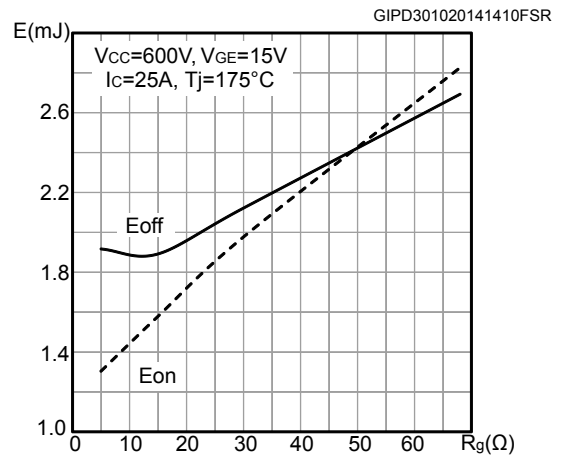
**Figure 14. Gate charge vs gate-emitter voltage**



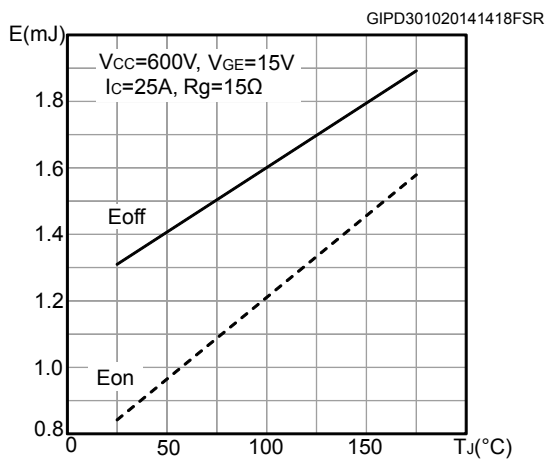
**Figure 15. Switching energy vs collector current**



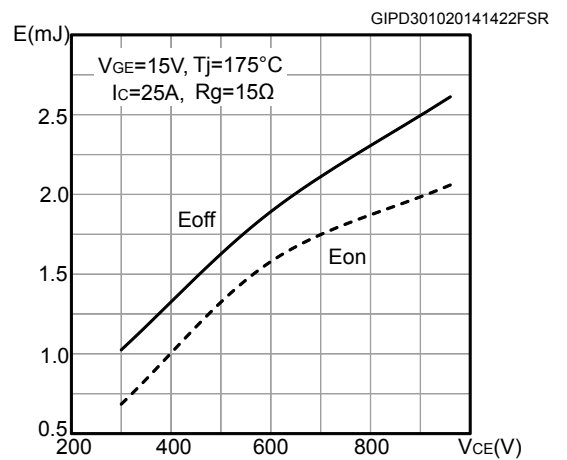
**Figure 16. Switching energy vs gate resistance**



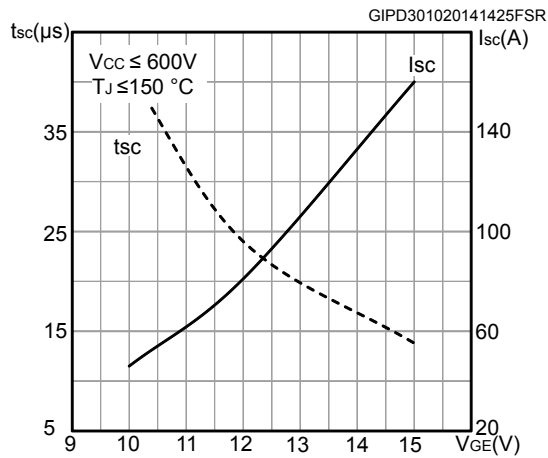
**Figure 17. Switching energy vs junction temperature**



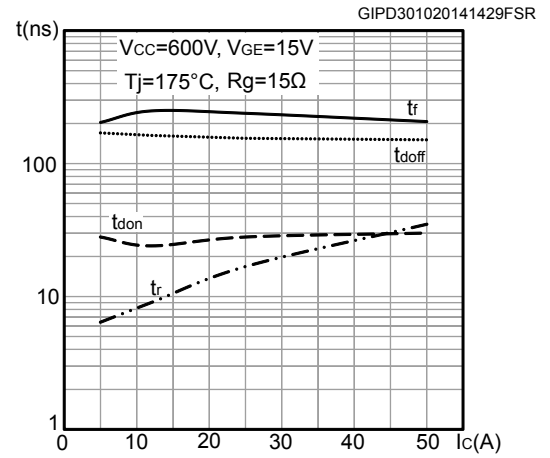
**Figure 18. Switching energy vs collector emitter voltage**



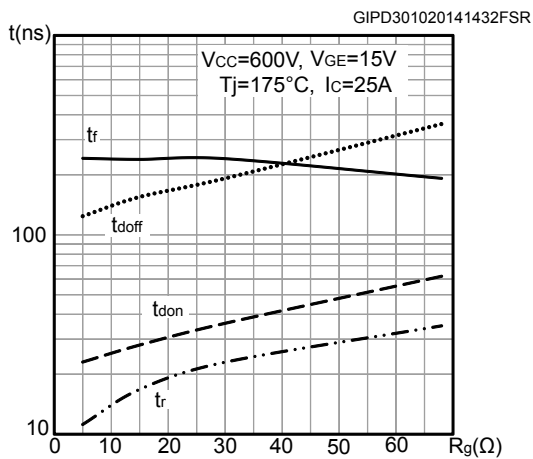
**Figure 19. Short-circuit time and current vs  $V_{GE}$**



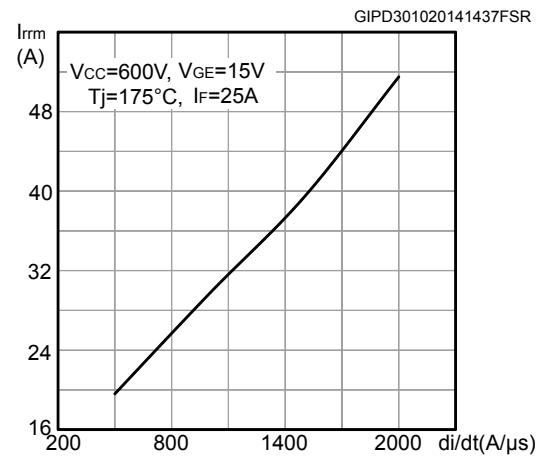
**Figure 20. Switching times vs collector current**



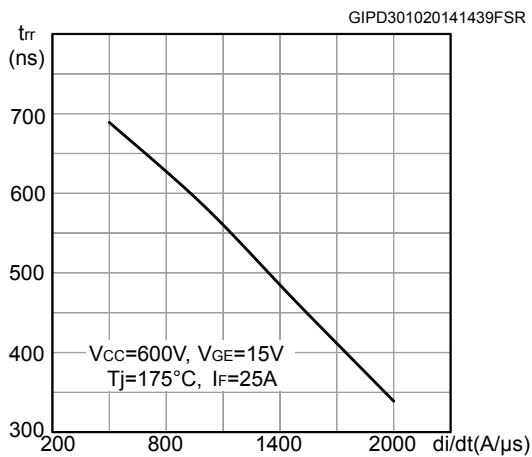
**Figure 21. Switching times vs gate resistance**



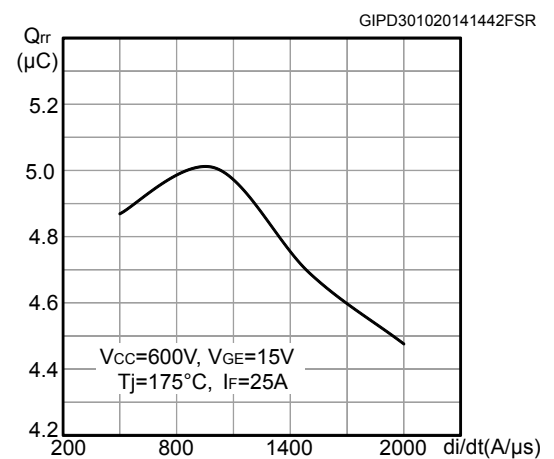
**Figure 22. Reverse recovery current vs diode current slope**



**Figure 23. Reverse recovery time vs diode current slope**

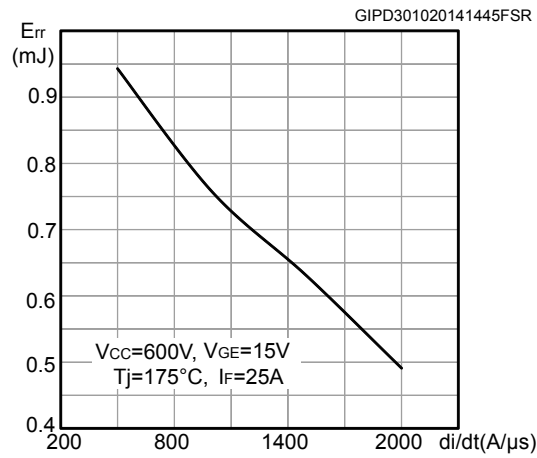


**Figure 24. Reverse recovery charge vs diode current slope**

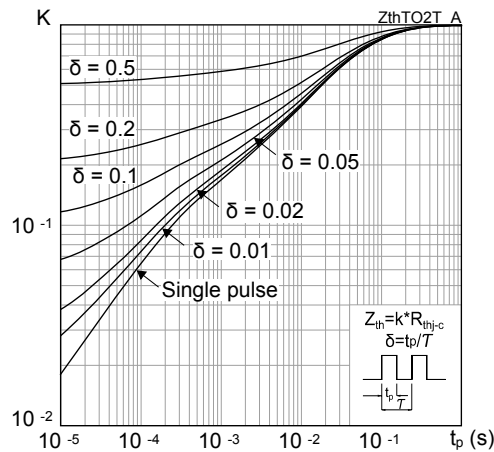




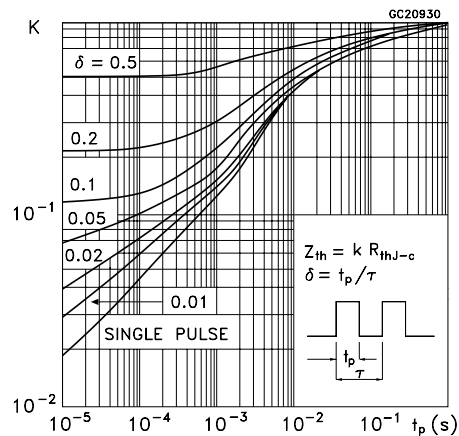
**Figure 25. Reverse recovery energy vs diode current slope**



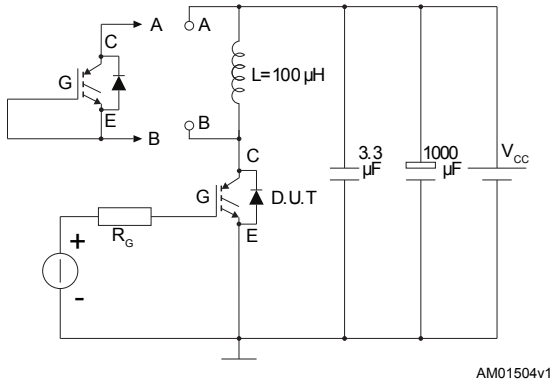
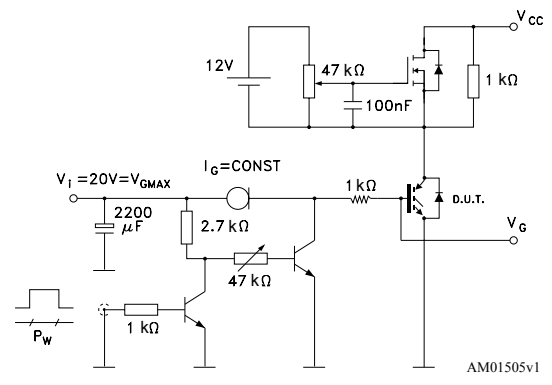
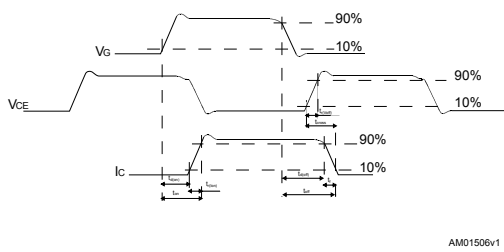
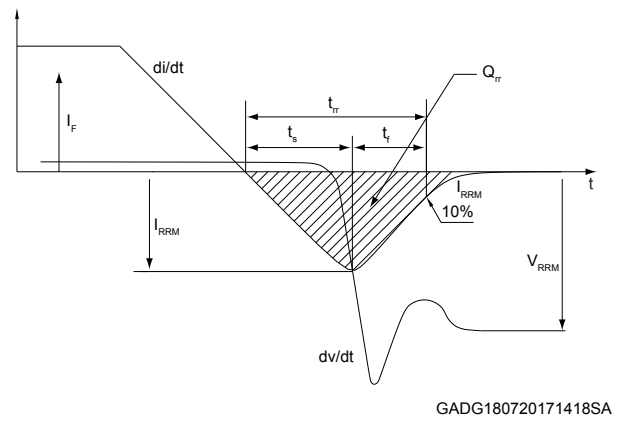
**Figure 26. Thermal impedance for IGBT**



**Figure 27. Thermal impedance for diode**



### 3 Test circuits

**Figure 28. Test circuit for inductive load switching**

**Figure 29. Gate charge test circuit**

**Figure 30. Switching waveform**

**Figure 31. Diode reverse recovery waveform**


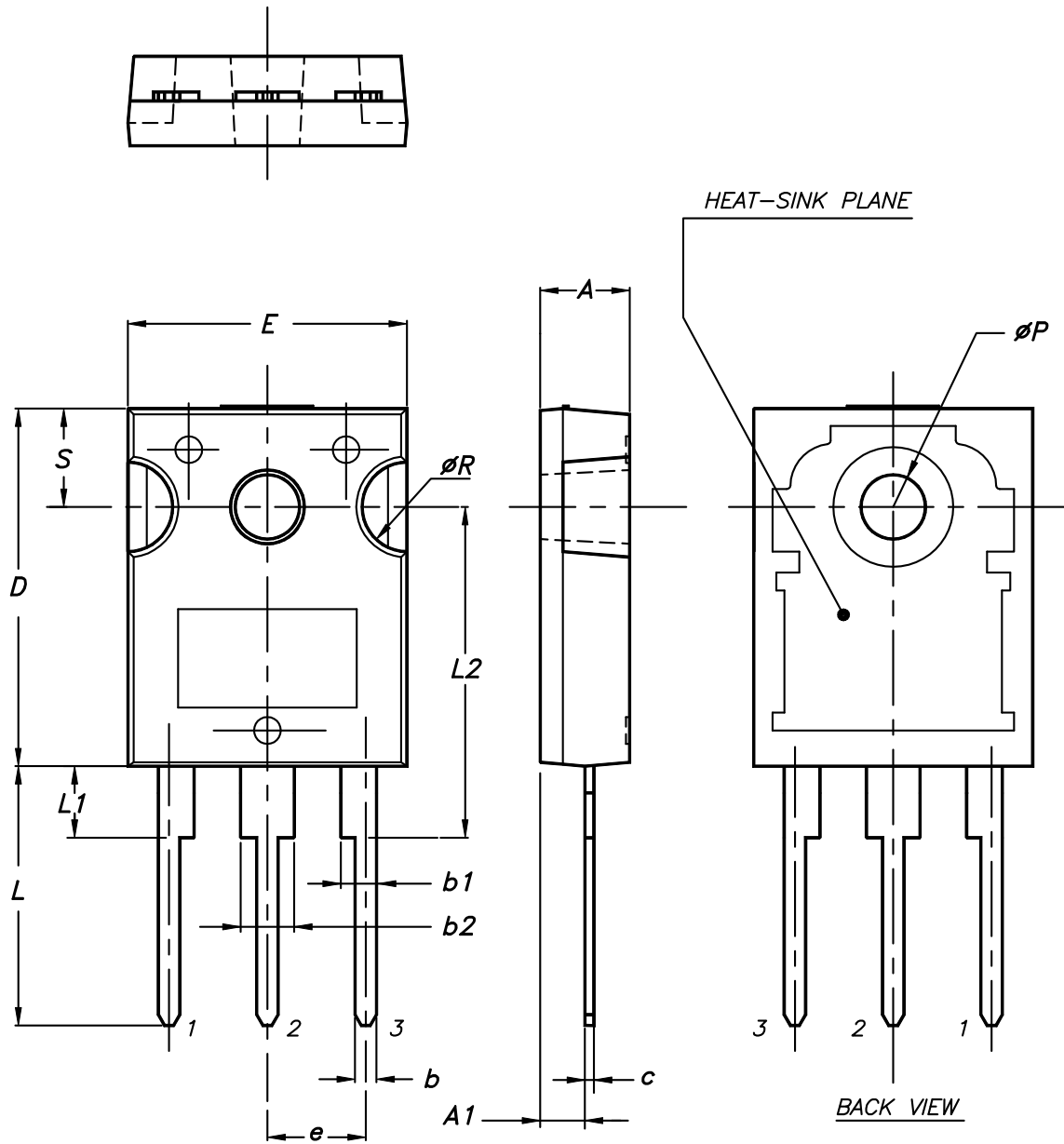
## 4 Package information

---

In order to meet environmental requirements, ST offers these devices in different grades of **ECOPACK** packages, depending on their level of environmental compliance. ECOPACK specifications, grade definitions and product status are available at: [www.st.com](http://www.st.com). ECOPACK is an ST trademark.

## 4.1 TO-247 package information

Figure 32. TO-247 package outline



0075325\_9

**Table 7. TO-247 package mechanical data**

Dim.	mm		
	Min.	Typ.	Max.
A	4.85		5.15
A1	2.20		2.60
b	1.0		1.40
b1	2.0		2.40
b2	3.0		3.40
c	0.40		0.80
D	19.85		20.15
E	15.45		15.75
e	5.30	5.45	5.60
L	14.20		14.80
L1	3.70		4.30
L2		18.50	
ØP	3.55		3.65
ØR	4.50		5.50
S	5.30	5.50	5.70

## Revision history

**Table 8. Document revision history**

Date	Version	Changes
22-Apr-2014	1	Initial release.
31-Oct-2014	2	Document status promoted from preliminary to production data. Updated all the document accordingly. Added <i>Section 2.1: Electrical characteristics (curves)</i> . Updated <i>Section 4: Package mechanical data</i> .
18-Jun-2018	3	The part number STGWA25M120DF3 has been moved to a separate datasheet, and the document has been updated accordingly. Updated features list on cover page. Updated <i>Table 1. Absolute maximum ratings</i> . Minor text changes
20-Nov-2019	4	Modified <a href="#">Table 3. Static characteristics</a> . Minor text changes.

---

## Contents

<b>1</b>	<b>Electrical ratings</b> .....	<b>2</b>
<b>2</b>	<b>Electrical characteristics</b> .....	<b>3</b>
<b>2.1</b>	<b>Electrical characteristics (curves)</b> .....	<b>5</b>
<b>3</b>	<b>Test circuits</b> .....	<b>10</b>
<b>4</b>	<b>Package information</b> .....	<b>11</b>
<b>4.1</b>	<b>TO-247 package information</b> .....	<b>11</b>
	<b>Revision history</b> .....	<b>14</b>

**IMPORTANT NOTICE – PLEASE READ CAREFULLY**

STMicroelectronics NV and its subsidiaries (“ST”) reserve the right to make changes, corrections, enhancements, modifications, and improvements to ST products and/or to this document at any time without notice. Purchasers should obtain the latest relevant information on ST products before placing orders. ST products are sold pursuant to ST’s terms and conditions of sale in place at the time of order acknowledgement.

Purchasers are solely responsible for the choice, selection, and use of ST products and ST assumes no liability for application assistance or the design of Purchasers’ products.

No license, express or implied, to any intellectual property right is granted by ST herein.

Resale of ST products with provisions different from the information set forth herein shall void any warranty granted by ST for such product.

ST and the ST logo are trademarks of ST. For additional information about ST trademarks, please refer to [www.st.com/trademarks](http://www.st.com/trademarks). All other product or service names are the property of their respective owners.

Information in this document supersedes and replaces information previously supplied in any prior versions of this document.

© 2019 STMicroelectronics – All rights reserved