

C1005X6S0J155K050BC

TDK Item Description : C1005X6S0J155KT****



Application & Main Feature

Commercial Grade (General (Up to 50V))

Series

C1005 [EIA CC0402]

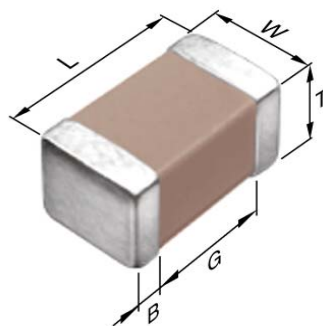

Dimensions

L 1.00mm +/-0.1mm
 W 0.50mm +/-0.1mm
 T 0.50mm +/-0.1mm
 B 0.10mm Min.
 G 0.30mm Min.

Temperature Characteristic

X6S (-55 to 105 degC +/-22%)

Rated Voltage

0J (6.3Vdc)

Capacitance

1.5uF

Capacitance Tolerance

K (+/-10%)

Dissipation Factor

10% Max.

Insulation Resistance

66Mohm Min.

AEC-Q200

Not Applicable

DC Bias Characteristic

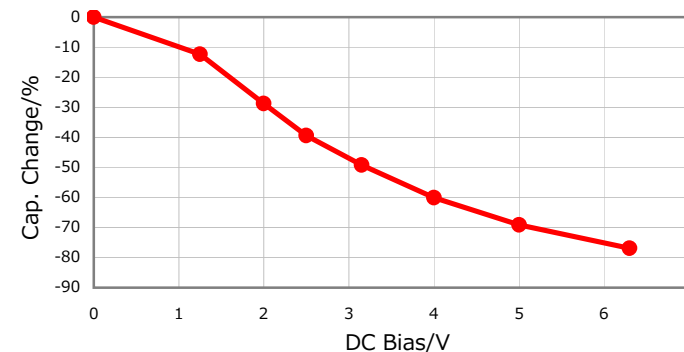

|Z|, ESR vs. Freq. Characteristics

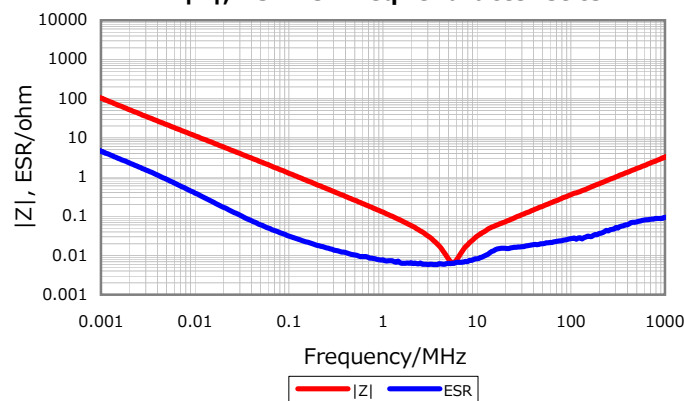

Temperature Characteristics

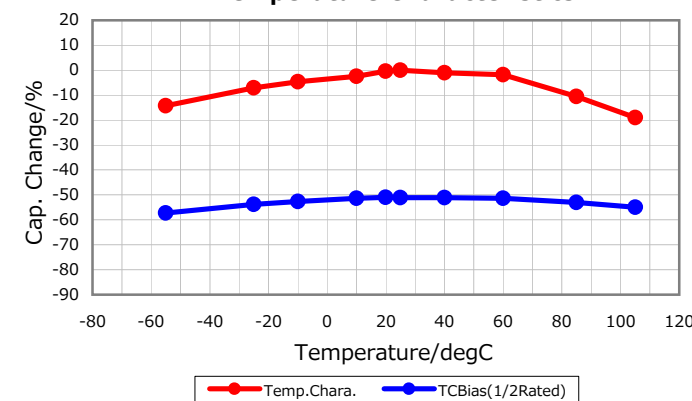

Cap. vs. Freq. Characteristic

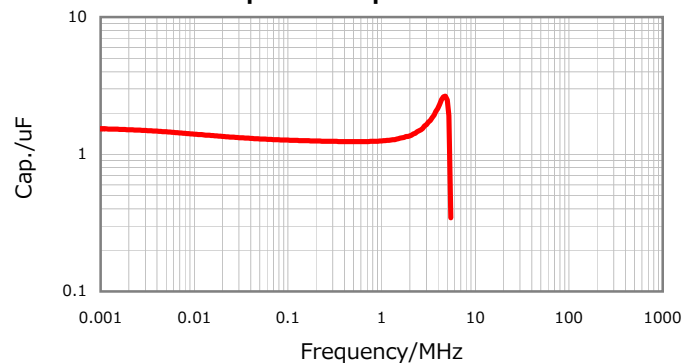

Ripple Temperature Rise Characteristics

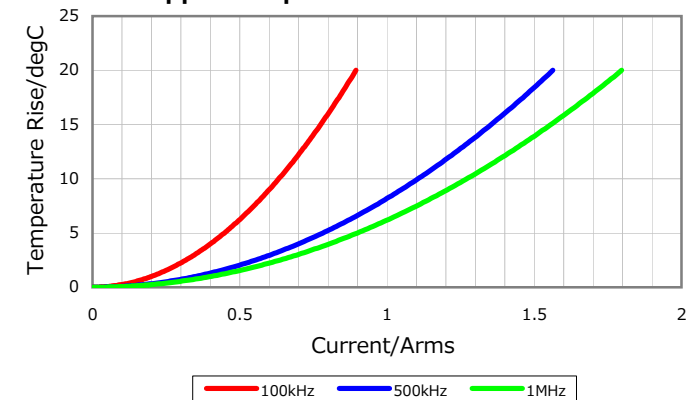

Characterization Sheet (Multilayer Ceramic Chip Capacitors)



All specifications are subject to change without notice.

January 3, 2016