

TL1454A, TL1454AY

DUAL-CHANNEL PULSE-WIDTH-MODULATION (PWM) CONTROL CIRCUIT

SLVS423 A– MAY 2002 – REVISED SEPTEMBER 2002

- Two Complete PWM Control Circuits
- Outputs Drive MOSFETs Directly
- Oscillator Frequency . . . 50 kHz to 2 MHz
- 3.6-V to 20-V Supply-Voltage Range
- Low Supply Current . . . 3.5 mA Typ
- Adjustable Dead-Time Control, 0% to 100%
- 1.26-V Reference

description

The TL1454A is a dual-channel pulse-width-modulation (PWM) control circuit, primarily intended for low-power, dc/dc converters. Applications include LCD displays, backlight inverters, notebook computers, and other products requiring small, high-frequency, dc/dc converters.

Each PWM channel has its own error amplifier, PWM comparator, dead-time control comparator, and MOSFET driver. The voltage reference, oscillator, undervoltage lockout, and short-circuit protection are common to both channels.

Channel 1 is configured to drive n-channel MOSFETs in step-up or flyback converters, and channel 2 is configured to drive p-channel MOSFETs in step-down or inverting converters. The operating frequency is set with an external resistor and an external capacitor, and dead time is continuously adjustable from 0 to 100% duty cycle with a resistive divider network. Soft start can be implemented by adding a capacitor to the dead-time control (DTC) network. The error-amplifier common-mode input range includes ground, which allows the TL1454A to be used in ground-sensing battery chargers as well as voltage converters.

D, N OR PW PACKAGE
(TOP VIEW)

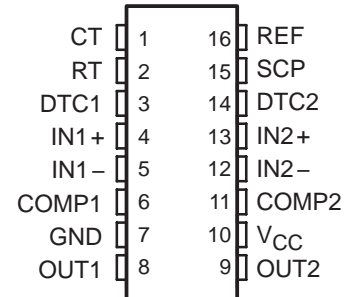

AVAILABLE OPTIONS

| T _A | PACKAGED DEVICES† | | | | | CHIP FORM (Y) |
|----------------|-------------------|-----------------|-------------|------------|---------------|---------------|
| | SMALL OUTLINE (D) | PLASTIC DIP (N) | TSSOP (PW) | SSOP (DB) | SOP-EIAJ (NS) | |
| –20°C to 85°C | TL1454ACD | TL1454ACN | TL1454ACPWR | TL1454ACDB | TL1454ACNS | TL1454AY |

† The D, DB and NS packages are available taped and reeled. Add the suffix R to the device name (e.g., TL1454ACDR). The PW package is available only left-end taped and reeled (indicated by the R suffix on the device type; e.g., TL1454ACPWR).

TL1454A, TL1454AY DUAL-CHANNEL PULSE-WIDTH-MODULATION (PWM) CONTROL CIRCUIT

SLVS423 A- MAY 2002 - REVISED SEPTEMBER 2002

functional block diagram

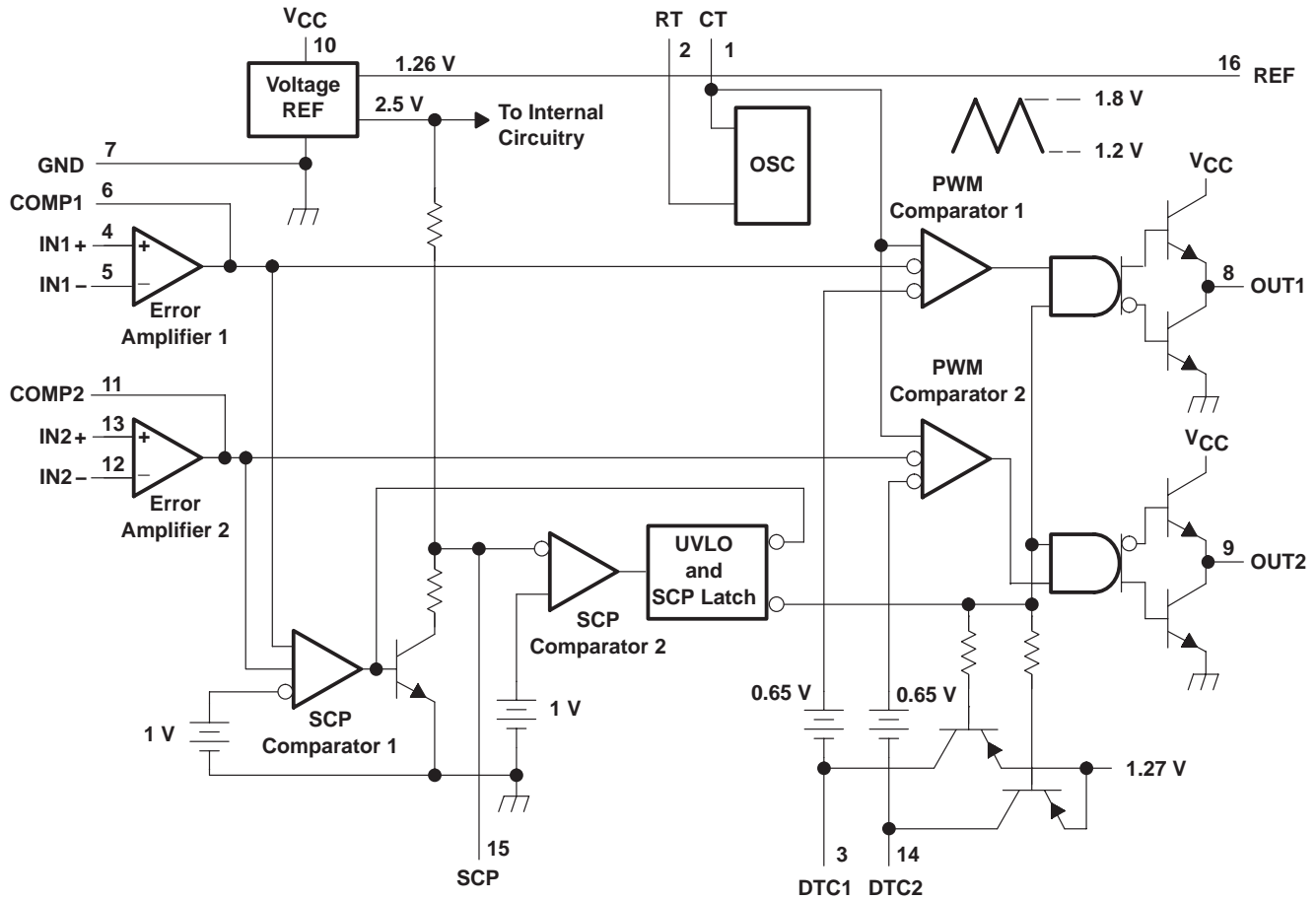

TL1454A, TL1454AY DUAL-CHANNEL PULSE-WIDTH-MODULATION (PWM) CONTROL CIRCUIT

SLVS423 A- MAY 2002 - REVISED SEPTEMBER 2002

TL1454AY chip information

This device, when properly assembled, displays characteristics similar to the TL1454AC. Thermal compression or ultrasonic bonding may be used on the doped aluminum bonding pads. The chips may be mounted with conductive epoxy or a gold-silicon preform.

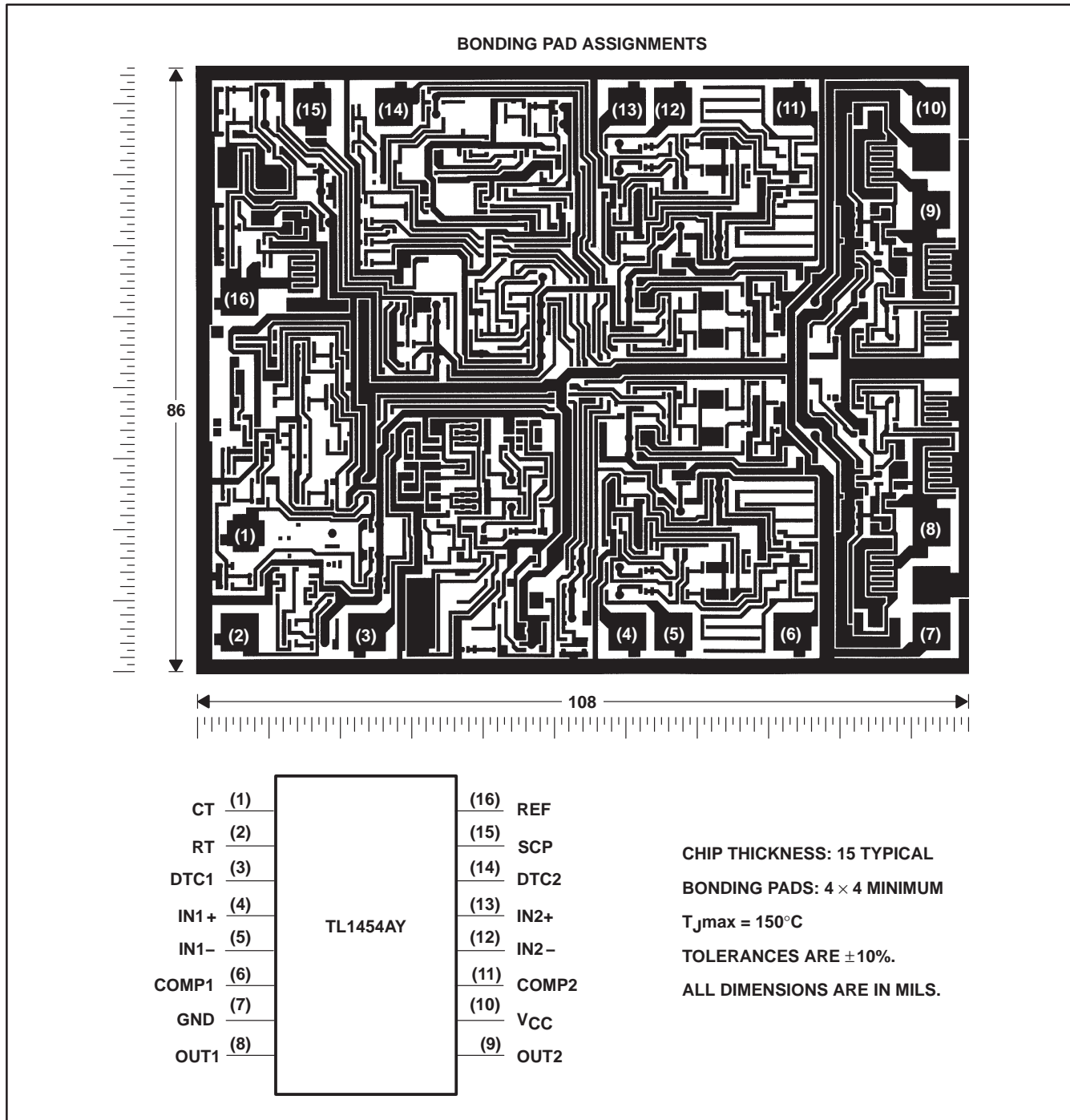

TL1454A, TL1454AY DUAL-CHANNEL PULSE-WIDTH-MODULATION (PWM) CONTROL CIRCUIT

SLVS423 A– MAY 2002 – REVISED SEPTEMBER 2002

theory of operation

reference voltage

A linear regulator operating from V_{CC} generates a 2.5-V supply for the internal circuits and the 1.26-V reference, which can source a maximum of 1 mA for external loads. A small ceramic capacitor (0.047 μ F to 0.1 μ F) between REF and ground is recommended to minimize noise pickup.

error amplifier

The error amplifier generates the error signal used by the PWM to adjust the power-switch duty cycle for the desired converter output voltage. The signal is generated by comparing a sample of the output voltage to the voltage reference and amplifying the difference. An external resistive divider connected between the converter output and ground, as shown in Figure 1, is generally required to obtain the output voltage sample.

The amplifier output is brought out on COMP to allow the frequency response of the amplifier to be shaped with an external RC network to stabilize the feedback loop of the converter. DC loading on the COMP output is limited to 45 μ A (the maximum amplifier source current capability).

Figure 1 illustrates the sense-divider network and error-amplifier connections for converters with positive output voltages. The divider network is connected to the noninverting amplifier input because the PWM has a phase inversion; the duty cycle decreases as the error-amplifier output increases.

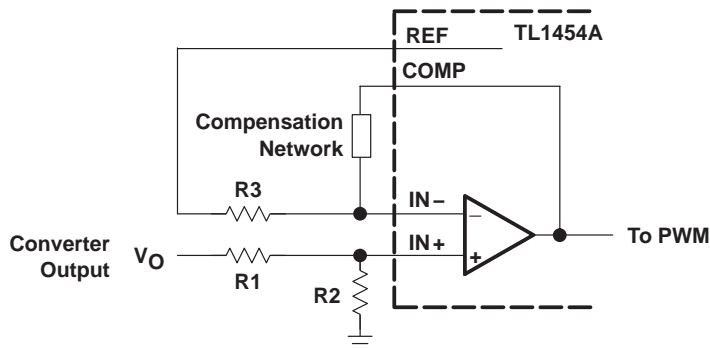

**Figure 1. Sense Divider/Error Amplifier
Configuration for Converters with Positive Outputs**

The output voltage is given by:

$$V_O = V_{ref} \left(1 + \frac{R_1}{R_2} \right)$$

where $V_{ref} = 1.26$ V.

The dc source resistance of the error-amplifier inputs should be 10 k Ω or less and approximately matched to minimize output voltage errors caused by the input-bias current. A simple procedure for determining appropriate values for the resistors is to choose a convenient value for R3 (10 k Ω or less) and calculate R1 and R2 using:

$$R_1 = \frac{R_3 V_O}{V_O - V_{ref}}$$

$$R_2 = \frac{R_3 V_O}{V_{ref}}$$

error amplifier

R1 and R2 should be tight-tolerance ($\pm 1\%$ or better) devices with low and/or matched temperature coefficients to minimize output voltage errors. A device with a $\pm 5\%$ tolerance is suitable for R3.

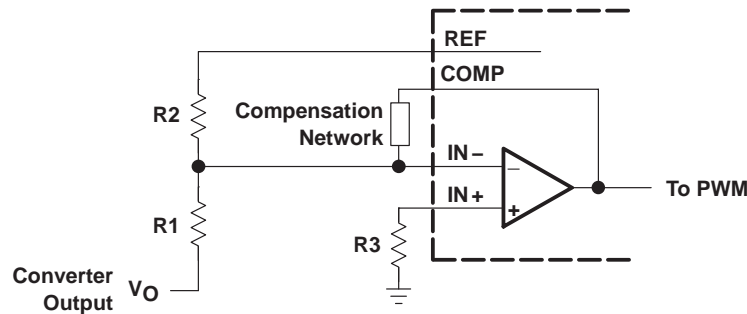

Figure 2. Sense Divider/Error Amplifier Configuration for Converters with Negative Outputs

Figure 2 shows the divider network and error-amplifier configuration for negative output voltages. In general, the comments for positive output voltages also apply for negative outputs. The output voltage is given by:

$$V_O = - \frac{R_1 V_{ref}}{R_2}$$

The design procedure for choosing the resistor value is to select a convenient value for R2 (instead of R3 in the procedure for positive outputs) and calculate R1 and R3 using:

$$R_1 = - \frac{R_2 V_O}{V_{ref}}$$

$$R_3 = \frac{R_1 R_2}{R_1 + R_2}$$

Values in the 10-k Ω to 20-k Ω range work well for R2. R3 can be omitted and the noninverting amplifier connected to ground in applications where the output voltage tolerance is not critical.

oscillator

The oscillator frequency can be set between 50 kHz and 2 MHz with a resistor connected between RT and GND and a capacitor between CT and GND (see Figure 3). Figure 6 is used to determine RT and CT for the desired operating frequency. Both components should be tight-tolerance, temperature-stable devices to minimize frequency deviation. A 1% metal-film resistor is recommended for RT, and a 10%, or better, NPO ceramic capacitor is recommended for CT.

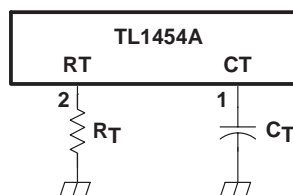

Figure 3. Oscillator Timing

TL1454A, TL1454AY

DUAL-CHANNEL PULSE-WIDTH-MODULATION (PWM) CONTROL CIRCUIT

SLVS423 A– MAY 2002 – REVISED SEPTEMBER 2002

dead-time control (DTC) and soft start

The two PWM channels have independent dead-time control inputs so that the maximum power-switch duty cycles can be limited to less than 100%. The dead-time is set with a voltage applied to DTC; the voltage is typically obtained from a resistive divider connected between the reference and ground as shown in Figure 4. Soft start is implemented by adding a capacitor between REF and DTC.

The voltage, V_{DT} , required to limit the duty cycle to a maximum value is given by:

$$V_{DT} = V_{O(max)} - D(V_{O(max)} - V_{O(min)}) - 0.65$$

where $V_{O(max)}$ and $V_{O(min)}$ are obtained from Figure 9, and D is the maximum duty cycle.

Predicting the regulator startup or rise time is complicated because it depends on many variables, including: input voltage, output voltage, filter values, converter topology, and operating frequency. In general, the output will be in regulation within two time constants of the soft-start circuit. A five-to-ten millisecond time constant usually works well for low-power converters.

The DTC input can be grounded in applications where achieving a 100% duty cycle is desirable, such as a buck converter with a very low input-to-output differential voltage. However, grounding DTC prevents the implementation of soft start, and the output voltage overshoot at power-on is likely to be very large. A better arrangement is to omit R_{DT1} (see Figure 4) and choose $R_{DT2} = 47 \text{ k}\Omega$. This configuration ensures that the duty cycle can reach 100% and still allows the designer to implement soft start using C_{SS} .

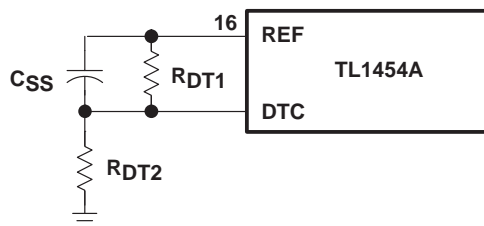

Figure 4. Dead-Time Control and Soft Start

PWM comparator

Each of the PWM comparators has dual inverting inputs. One inverting input is connected to the output of the error amplifier; the other inverting input is connected to the DTC terminal. Under normal operating conditions, when either the error-amplifier output or the dead-time control voltage is higher than that for the PWM triangle wave, the output stage is set inactive (OUT1 low and OUT2 high), turning the external power stage off.

undervoltage-lockout (UVLO) protection

The undervoltage-lockout circuit turns the output circuit off and resets the SCP latch whenever the supply voltage drops too low (to approximately 2.9 V) for proper operation. A hysteresis voltage of 200 mV eliminates false triggering on noise and chattering.

short-circuit protection (SCP)

The TL1454A SCP function prevents damage to the power switches when the converter output is shorted to ground. In normal operation, SCP comparator 1 clamps SCP to approximately 185 mV. When one of the converter outputs is shorted, the error amplifier output (COMP) will be driven below 1 V to maximize duty cycle and force the converter output back up. When the error amplifier output drops below 1 V, SCP comparator 1 releases SCP, and capacitor, C_{SCP} , which is connected between SCP and GND, begins charging. If the error-amplifier output rises above 1 V before C_{SCP} is charged to 1 V, SCP comparator 1 discharges C_{SCP} and normal operation resumes. If C_{SCP} reaches 1 V, SCP comparator 2 turns on and sets the SCP latch, which turns off the output drives and resets the soft-start circuit. The latch remains set until the supply voltage is lowered to 2 V or less, or C_{SCP} is discharged externally.

TL1454A, TL1454AY DUAL-CHANNEL PULSE-WIDTH-MODULATION (PWM) CONTROL CIRCUIT

SLVS423 A– MAY 2002 – REVISED SEPTEMBER 2002

short-circuit protection (SCP) (continued)

The SCP time-out period must be greater than the converter start-up time or the converter will not start. Because high-value capacitor tolerances tend to be $\pm 20\%$ or more and IC resistor tolerances are loose as well, it is best to choose an SCP time-out period 10-to-15 times greater than the converter startup time. The value of C_{SCP} may be determined using Figure 6, or it can be calculated using:

$$C_{SCP} = \frac{T_{SCP}}{80.3}$$

where C_{SCP} is in μF and T_{SCP} is the time-out period in ms.

output stage

The output stage of the TL1454A is a totem-pole output with a maximum source/sink current rating of 40 mA and a voltage rating of 20 V. The output is controlled by a complementary output AND gate and is turned on (sourcing current for OUT1, sinking current for OUT2) when all the following conditions are met: 1) the oscillator triangle wave voltage is higher than both the DTC voltage and the error-amplifier output voltage, 2) the undervoltage-lockout circuit is inactive, and 3) the short-circuit protection circuit is inactive.

absolute maximum ratings over operating free-air temperature range (unless otherwise noted)[†]

| | |
|--|--|
| Supply voltage, V_{CC} (see Note 1) | 23 V |
| Error amplifier input voltage: IN1+, IN1–, IN2+, IN2– | 23 V |
| Output voltage: OUT1, OUT2 | 20 V |
| Continuous output current: OUT1, OUT2 | ± 200 mA |
| Peak output current: OUT1, OUT2 | 1 A |
| Continuous total dissipation | See Dissipation Rating Table |
| Operating free-air temperature range, T_A : C suffix | -20°C to 85°C |
| Storage temperature range, T_{stg} | -65°C to 150°C |
| Lead temperature 1,6 mm (1/16 inch) from case for 10 seconds | 260°C |

[†] Stresses beyond those listed under “absolute maximum ratings” may cause permanent damage to the device. These are stress ratings only, and functional operation of the device at these or any other conditions beyond those indicated under “recommended operating conditions” is not implied. Exposure to absolute-maximum-rated conditions for extended periods may affect device reliability.

NOTE 1: All voltage values are with respect to network GND.

DISSIPATION RATING TABLE

| PACKAGE | $T_A \leq 25^\circ\text{C}$ POWER RATING | DERATING FACTOR ABOVE $T_A = 25^\circ\text{C}$ | $T_A = 70^\circ\text{C}$ POWER RATING | $T_A = 85^\circ\text{C}$ POWER RATING |
|---------|---|---|--|--|
| D | 950 mW | 7.6 mW/ $^\circ\text{C}$ | 608 mW | 494 mW |
| DB | 1000 mW | 8.0 mW/ $^\circ\text{C}$ | 640 mW | 520 mW |
| N | 1250 mW | 10.0 mW/ $^\circ\text{C}$ | 800 mW | 650 mW |
| NS | 1953 mW | 15.6 mW/ $^\circ\text{C}$ | 1250 mW | 1015 mW |
| PW | 500 mW | 4.0 mW/ $^\circ\text{C}$ | 320 mW | 260 mW |



TL1454A, TL1454AY DUAL-CHANNEL PULSE-WIDTH-MODULATION (PWM) CONTROL CIRCUIT

SLVS423 A– MAY 2002 – REVISED SEPTEMBER 2002

recommended operating conditions

| | | MIN | MAX | UNIT |
|---|----------|------|------|------|
| Supply voltage, V_{CC} | | 3.6 | 20 | V |
| Error amplifier common-mode input voltage | | -0.2 | 1.45 | V |
| Output voltage, V_O | | | 20 | V |
| Output current, I_O | | | ±40 | mA |
| COMP source current | | | -45 | μA |
| COMP sink current | | | 100 | μA |
| Reference output current | | | 1 | mA |
| COMP dc load resistance | | 100 | | kΩ |
| Timing capacitor, C_T | | 10 | 4000 | pF |
| Timing resistor, R_T | | 5.1 | 100 | kΩ |
| Oscillator frequency | | 50 | 2000 | kHz |
| Operating free-air temperature, T_A | TL1454AC | -20 | 85 | °C |

electrical characteristics over recommended operating free-air temperature range, $V_{CC} = 6\text{ V}$, $f_{osc} = 500\text{ kHz}$ (unless otherwise noted)

reference

| PARAMETER | TEST CONDITIONS | TL1454A | | | UNIT |
|--|---|---------|-------|------|------|
| | | MIN | TYP | MAX | |
| V_{ref} Output voltage, REF | $I_O = 1\text{ mA}$, $T_A = 25^\circ\text{C}$ | 1.22 | 1.26 | 1.32 | V |
| | $I_O = 1\text{ mA}$ | 1.20 | | 1.34 | |
| Input regulation | $V_{OC} = 3.6\text{ V to }20\text{ V}$, $I_O = 1\text{ mA}$ | | 2 | 6 | mV |
| Output regulation | $I_O = 0.1\text{ mA to }1\text{ mA}$ | | 1 | 7.5 | mV |
| Output voltage change with temperature | $T_A = T_{A(\text{min})}$ to 25°C , $I_O = 1\text{ mA}$ | -12.5 | -1.25 | 12.5 | mV |
| | $T_A = 25^\circ\text{C}$ to 85°C , $I_O = 1\text{ mA}$ | -12.5 | -2.5 | 12.5 | |
| I_{OS} Short-circuit output current | $V_{ref} = 0\text{ V}$ | | 30 | | mA |

undervoltage lockout (UVLO)

| PARAMETER | TEST CONDITIONS | TL1454A | | | UNIT |
|--|--------------------------|---------|-----|-----|------|
| | | MIN | TYP | MAX | |
| V_{IT+} Positive-going threshold voltage | $T_A = 25^\circ\text{C}$ | | 2.9 | | V |
| V_{IT-} Negative-going threshold voltage | | | 2.7 | | V |
| V_{hys} Hysteresis, $V_{IT+} - V_{IT-}$ | | 100 | 200 | | mV |

short-circuit protection (SCP)

| PARAMETER | TEST CONDITIONS | TL1454A | | | UNIT |
|--|--|---------|-----|------|------|
| | | MIN | TYP | MAX | |
| V_{IT} Input threshold voltage | $T_A = 25^\circ\text{C}$ | 0.93 | 1 | 1.07 | V |
| V_{stby}^\dagger Standby voltage | No pullup | 140 | 185 | 230 | mV |
| $V_{I(\text{latched})}$ Latched-mode input voltage | | 60 | 120 | | mV |
| $V_{IT(\text{COMP})}$ Comparator threshold voltage | COMP1, COMP2 | | 1 | | V |
| Input source current | $T_A = 25^\circ\text{C}$, $V_{O(\text{SCP})} = 0$ | -5 | -15 | -20 | μA |

[†] This symbol is not presently listed within EIA/JEDEC standards for semiconductor symbology.



TL1454A, TL1454AY

DUAL-CHANNEL PULSE-WIDTH-MODULATION (PWM) CONTROL CIRCUIT

SLVS423 A– MAY 2002 – REVISED SEPTEMBER 2002

electrical characteristics over recommended operating free-air temperature range, $V_{CC} = 6\text{ V}$, $f_{osc} = 500\text{ kHz}$ (unless otherwise noted) (continued)

oscillator

| PARAMETER | TEST CONDITIONS | TL1454A | | | UNIT |
|-----------------------------------|---|---------|-----|----------|------|
| | | MIN | TYP | MAX | |
| f_{osc} Frequency | $C_T = 120\text{ pF}$, $R_T = 10\text{ k}\Omega$ | | 500 | | kHz |
| Standard deviation of frequency | | | 50 | | kHz |
| Frequency change with voltage | $V_{CC} = 3.6\text{ V to }20\text{ V}$, $T_A = 25^\circ\text{C}$ | | 10 | | kHz |
| Frequency change with temperature | $T_A = T_{A(\text{min})}$ to 25°C | | -2 | ± 30 | kHz |
| | $T_A = 25^\circ\text{C}$ to 85°C | | -10 | ± 30 | |
| Maximum ramp voltage | | | 1.8 | | V |
| Minimum ramp voltage | | | 1.1 | | V |

dead-time control (DTC)

| PARAMETER | TEST CONDITIONS | TL1454A | | | UNIT |
|--|-----------------------------------|---------|------|------|---------------|
| | | MIN | TYP | MAX | |
| V_{IT} Input threshold voltage | Duty cycle = 0% | 0.98 | 1.1 | 1.22 | V |
| | Duty cycle = 100% | 0.38 | 0.5 | 0.62 | |
| $V_{I(\text{latched})}$ Latched-mode input voltage | | | 1.2 | | V |
| I_{IB} Common-mode input bias current | DTC1, $IN1+ \approx 1.2\text{ V}$ | | | 4 | μA |
| Latched-mode (source) current | $T_A = 25^\circ\text{C}$ | | -100 | | μA |

error-amplifier

| PARAMETER | TEST CONDITIONS | TL1454A | | | UNIT |
|--|--|--------------|------|------|---------------|
| | | MIN | TYP | MAX | |
| V_{IO} Input offset voltage | $V_O = 1.25\text{ V}$, $V_{IC} = 1.25\text{ V}$ | | | 6 | mV |
| I_{IO} Input offset current | | | | 100 | nA |
| I_{IB} Input bias current | | | -160 | -500 | nA |
| V_{ICR} Input voltage range | $V_{CC} = 3.6\text{ V to }20\text{ V}$ | -0.2 to 1.40 | | | V |
| A_V Open-loop voltage gain | $R_{FB} = 200\text{ k}\Omega$ | 70 | 80 | | dB |
| Unity-gain bandwidth | | | 3 | | MHz |
| CMRR Common-mode rejection ratio | | 60 | 80 | | dB |
| $V_{OM(\text{max})}$ Positive output voltage swing | | 2.3 | 2.43 | | V |
| $V_{OM(\text{min})}$ Negative output voltage swing | | | 0.63 | 0.8 | |
| I_{O+} Output sink current | $V_{ID} = -0.1\text{ V}$, $V_O = 1.20\text{ V}$ | 0.1 | 0.5 | | mA |
| I_{O-} Output source current | $V_{ID} = 0.1\text{ V}$, $V_O = 1.80\text{ V}$ | -45 | -70 | | μA |

output

| PARAMETER | TEST CONDITIONS | TL1454A | | | UNIT |
|------------------------------------|---|-----------------------|-----|-----|------|
| | | MIN | TYP | MAX | |
| V_{OH} High-level output voltage | $I_O = -8\text{ mA}$ | $V_{CC}-2$ | 4.5 | | V |
| | $I_O = -8\text{ mA}$ @ $V_{CC} = >10\text{ V}$ | $V_{CC}-2.3\text{ V}$ | | | |
| | $I_O = -40\text{ mA}$ | $V_{CC}-2$ | 4.4 | | |
| | $I_O = 40\text{ mA}$ @ $V_{CC} = >10\text{ V}$ | $V_{CC}-2.3\text{ V}$ | | | |
| V_{OL} Low-level output voltage | $I_O = 8\text{ mA}$ | | 0.1 | 0.4 | V |
| | $I_O = 40\text{ mA}$ | | 1.8 | 2.5 | |
| t_{rv} Output voltage rise time | $C_L = 2000\text{ pF}$, $T_A = 25^\circ\text{C}$ | | 220 | | ns |
| t_{fv} Output voltage fall time | | | 220 | | |



TL1454A, TL1454AY

DUAL-CHANNEL PULSE-WIDTH-MODULATION (PWM) CONTROL CIRCUIT

SLVS423 A– MAY 2002 – REVISED SEPTEMBER 2002

electrical characteristics over recommended operating free-air temperature range, $V_{CC} = 6\text{ V}$, $f_{osc} = 500\text{ kHz}$ (unless otherwise noted) (continued)

supply current

| PARAMETER | TEST CONDITIONS | TL1454A | | | UNIT |
|--|---|---------|-----|-----|------|
| | | MIN | TYP | MAX | |
| $I_{CC(stby)}$ Standby supply current | R_T open, $C_T = 1.5\text{ V}$, No load, V_O (COMP1, COMP2) = 1.25 V, | | 3.1 | 6 | mA |
| $I_{CC(average)}$ Average supply current | $R_T = 10\text{ k}\Omega$, $C_T = 120\text{ pF}$, 50% duty cycle, Outputs open | | 3.5 | 7 | mA |

electrical characteristics, $V_{CC} = 6\text{ V}$, $f_{osc} = 500\text{ kHz}$, $T_A = 25^\circ\text{C}$ (unless otherwise noted)

reference

| PARAMETER | TEST CONDITIONS | TL1454AY | | | UNIT |
|--|--|----------|-------|-----|------|
| | | MIN | TYP | MAX | |
| V_{ref} Output voltage, REF | $I_O = 1\text{ mA}$ | | 1.26 | | V |
| Input regulation | $V_{OC} = 3.6\text{ V to }20\text{ V}$, $I_O = 1\text{ mA}$ | | 2 | | mV |
| Output regulation | $I_O = 0.1\text{ mA to }1\text{ mA}$ | | 1 | | mV |
| Output voltage change with temperature | $I_O = 1\text{ mA}$ | | -1.25 | | mV |
| | $I_O = 1\text{ mA}$ | | -2.5 | | |
| I_{OS} Short-circuit output current | $V_{ref} = 0\text{ V}$ | | 30 | | mA |

undervoltage lockout (UVLO)

| PARAMETER | TEST CONDITIONS | TL1454AY | | | UNIT |
|--|-----------------|----------|-----|-----|------|
| | | MIN | TYP | MAX | |
| V_{IT+} Positive-going threshold voltage | | | 2.9 | | V |
| V_{IT-} Negative-going threshold voltage | | | 2.7 | | V |
| V_{hys} Hysteresis, $V_{IT+} - V_{IT-}$ | | | 200 | | mV |

short-circuit protection (SCP)

| PARAMETER | TEST CONDITIONS | TL1454AY | | | UNIT |
|---|------------------|----------|-----|-----|---------------|
| | | MIN | TYP | MAX | |
| V_{IT} Input threshold voltage | | | 1 | | V |
| V_{stby}^\dagger Standby voltage | No pullup | | 185 | | mV |
| $V_{I(latched)}$ Latched-mode input voltage | | | 60 | | mV |
| $V_{IT(COMP)}$ Comparator threshold voltage | COMP1, COMP2 | | 1 | | V |
| Input source current | $V_{O(SCP)} = 0$ | | -15 | | μA |

† This symbol is not presently listed within EIA/JEDEC standards for semiconductor symbology.

oscillator

| PARAMETER | TEST CONDITIONS | TL1454AY | | | UNIT |
|-----------------------------------|---|----------|-----|-----|------|
| | | MIN | TYP | MAX | |
| f_{osc} Frequency | $C_T = 120\text{ pF}$, $R_T = 10\text{ k}\Omega$ | | 500 | | kHz |
| Standard deviation of frequency | | | 50 | | kHz |
| Frequency change with voltage | $V_{CC} = 3.6\text{ V to }20\text{ V}$ | | 10 | | kHz |
| Frequency change with temperature | $T_A = T_{A(min)}$ to 25°C | | -2 | | kHz |
| | $T_A = 25^\circ\text{C}$ to 85°C | | -10 | | |
| Maximum ramp voltage | | | 1.8 | | V |
| Minimum ramp voltage | | | 1.1 | | V |



TL1454A, TL1454AY

DUAL-CHANNEL PULSE-WIDTH-MODULATION (PWM) CONTROL CIRCUIT

SLVS423 A– MAY 2002 – REVISED SEPTEMBER 2002

electrical characteristics, $V_{CC} = 6\text{ V}$, $f_{osc} = 500\text{ kHz}$, $T_A = 25^\circ\text{C}$ (unless otherwise noted) (continued)

dead-time control (DTC)

| PARAMETER | TEST CONDITIONS | TL1454AY | | | UNIT |
|---|-------------------|----------|-----|-----|---------------|
| | | MIN | TYP | MAX | |
| V_{IT} Input threshold voltage | Duty cycle = 0% | 1.1 | | | V |
| | Duty cycle = 100% | 0.5 | | | |
| $V_{I(latched)}$ Latched-mode input voltage | | 1.2 | | | V |
| Latched-mode (source) current | | –100 | | | μA |

error-amplifier

| PARAMETER | TEST CONDITIONS | TL1454AY | | | UNIT |
|---|--|----------|-----|-----|---------------|
| | | MIN | TYP | MAX | |
| I_{IB} Input bias current | $V_O = 1.25\text{ V}$, $V_{IC} = 1.25\text{ V}$ | –160 | | | nA |
| A_V Open-loop voltage gain | $R_{FB} = 200\text{ k}\Omega$ | 80 | | | dB |
| Unity-gain bandwidth | | 3 | | | MHz |
| CMRR Common-mode rejection ratio | | 80 | | | dB |
| $V_{OM(max)}$ Positive output voltage swing | | 2.43 | | | V |
| $V_{OM(min)}$ Negative output voltage swing | | 0.63 | | | |
| I_{O+} Output sink current | $V_{ID} = -0.1\text{ V}$, $V_O = 1.20\text{ V}$ | 0.5 | | | mA |
| I_{O-} Output source current | $V_{ID} = 0.1\text{ V}$, $V_O = 1.80\text{ V}$ | –70 | | | μA |

output

| PARAMETER | TEST CONDITIONS | TL1454AY | | | UNIT |
|------------------------------------|------------------------|----------|-----|-----|------|
| | | MIN | TYP | MAX | |
| V_{OH} High-level output voltage | $I_O = -8\text{ mA}$ | 4.5 | | | V |
| | $I_O = -40\text{ mA}$ | 4.4 | | | |
| V_{OL} Low-level output voltage | $I_O = 8\text{ mA}$ | 0.1 | | | V |
| | $I_O = 40\text{ mA}$ | 1.8 | | | |
| t_{rv} Output voltage rise time | $C_L = 2000\text{ pF}$ | 220 | | | ns |
| t_{fv} Output voltage fall time | | 220 | | | |

supply current

| PARAMETER | TEST CONDITIONS | TL1454AY | | | UNIT |
|--|---|----------|-----|-----|------|
| | | MIN | TYP | MAX | |
| $I_{CC(stby)}$ Standby supply current | RT open, $C_T = 1.5\text{ V}$, No load, V_O (COMP1, COMP2) = 1.25 V, | 3.1 | | | mA |
| $I_{CC(average)}$ Average supply current | $R_T = 10\text{ k}\Omega$, $C_T = 120\text{ pF}$, 50% duty cycle, Outputs open | 3.5 | | | mA |

TL1454A, TL1454AY DUAL-CHANNEL PULSE-WIDTH-MODULATION (PWM) CONTROL CIRCUIT

SLVS423 A- MAY 2002 - REVISED SEPTEMBER 2002

PARAMETER MEASUREMENT INFORMATION

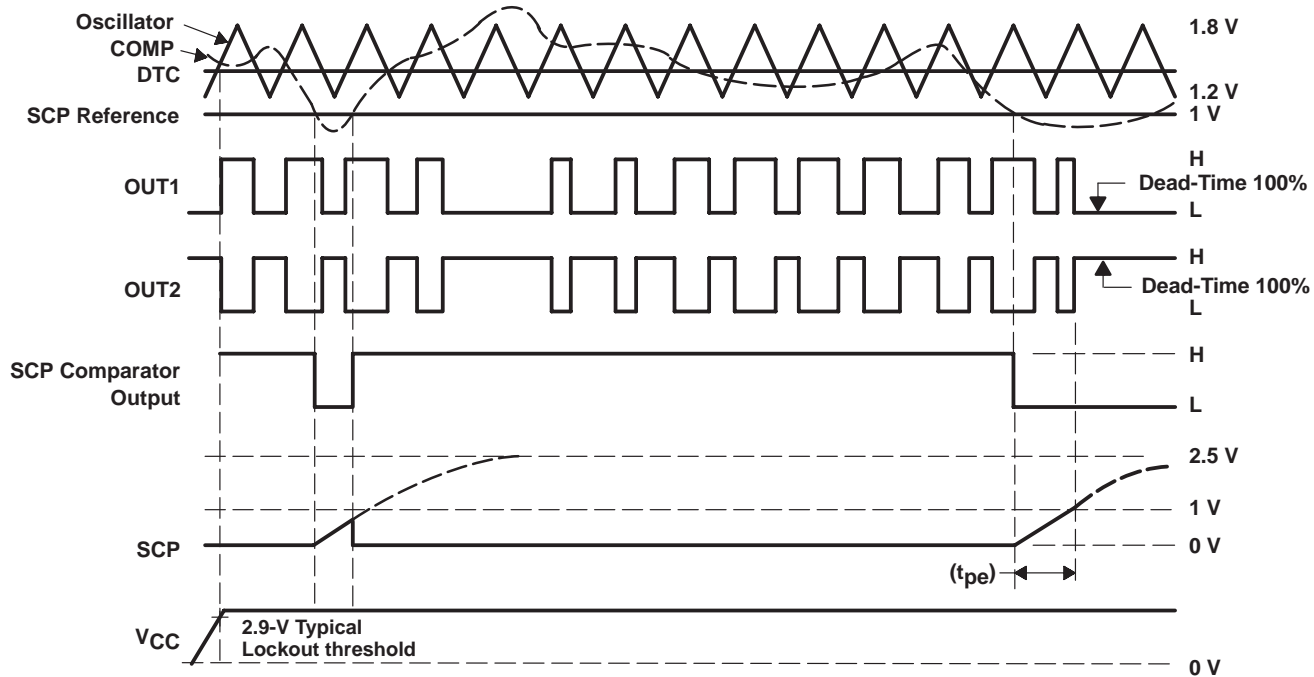

Figure 5. Timing Diagram

TYPICAL CHARACTERISTICS

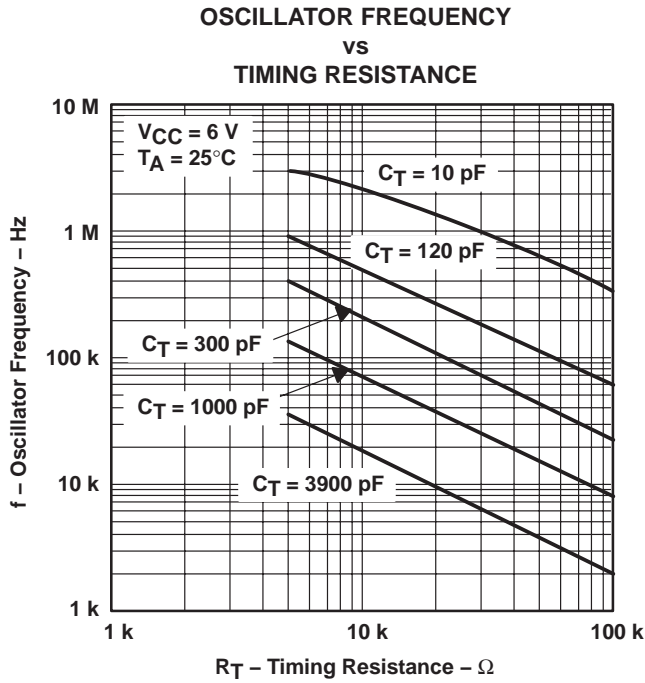

Figure 6

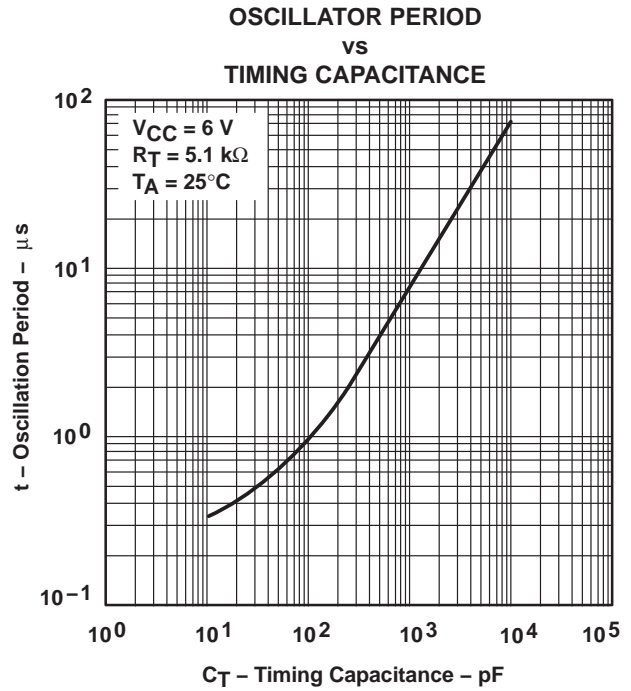

Figure 7

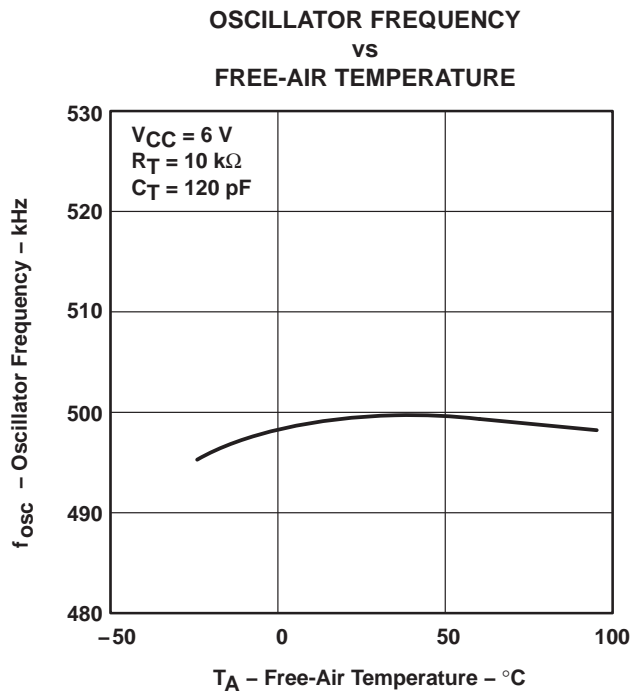

Figure 8

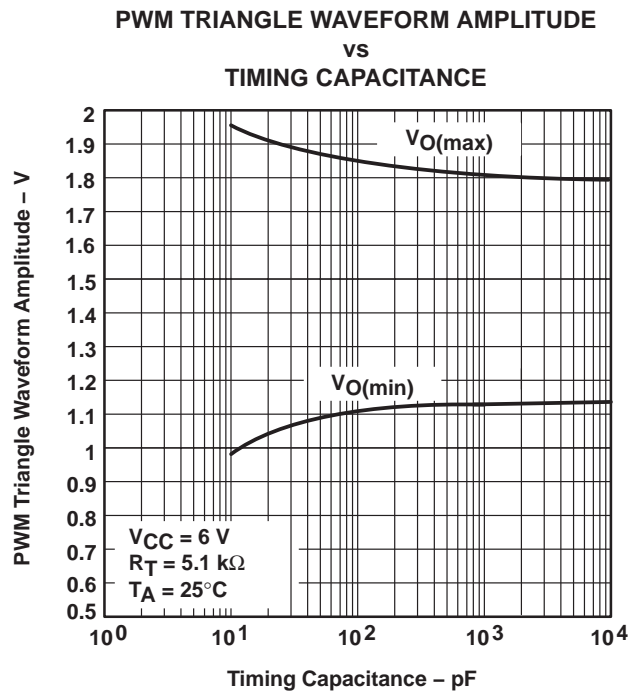
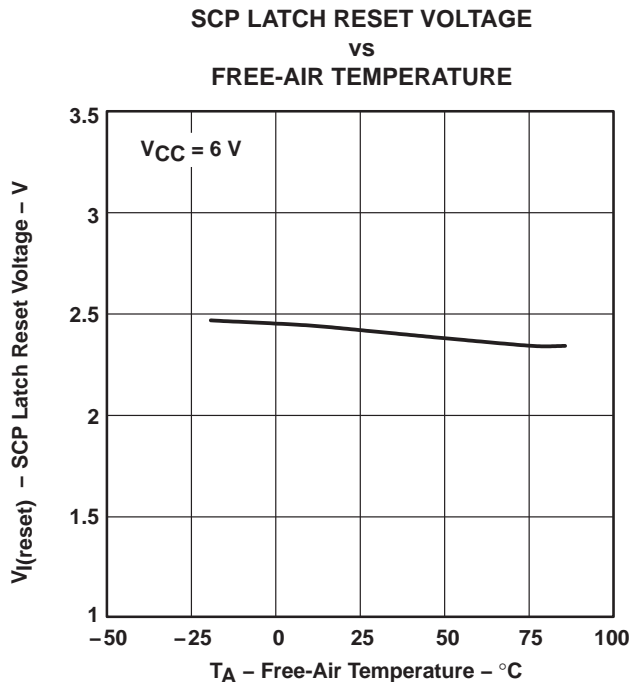
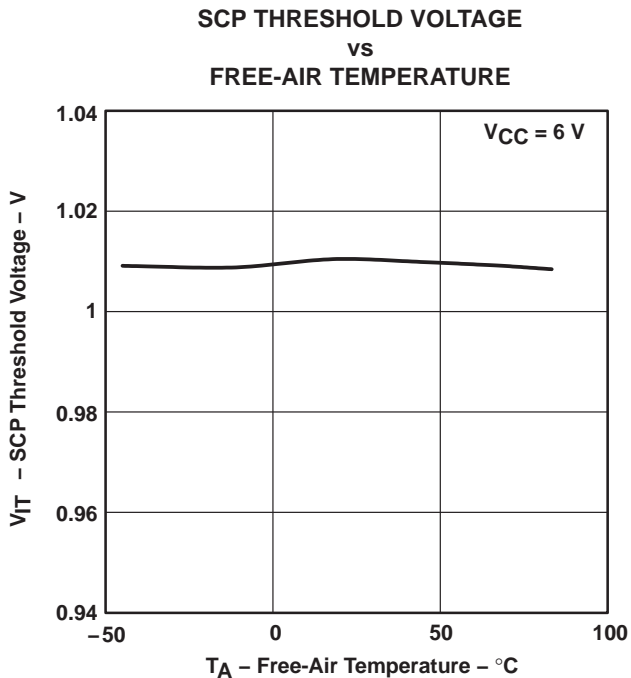
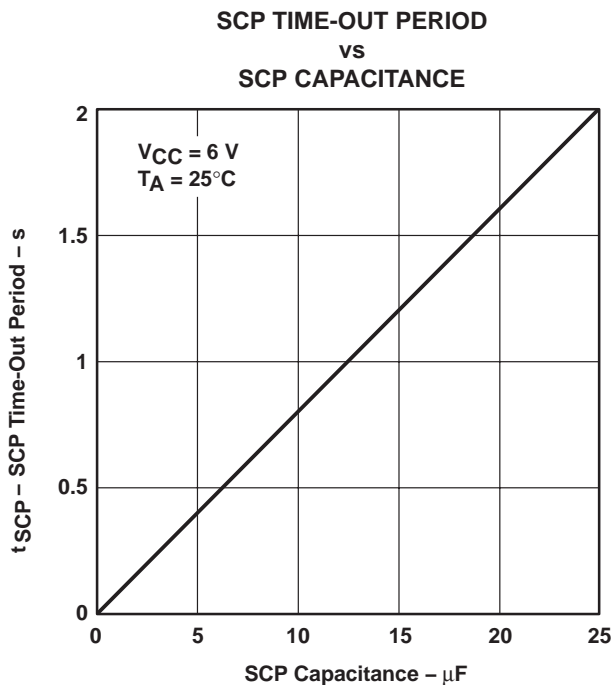
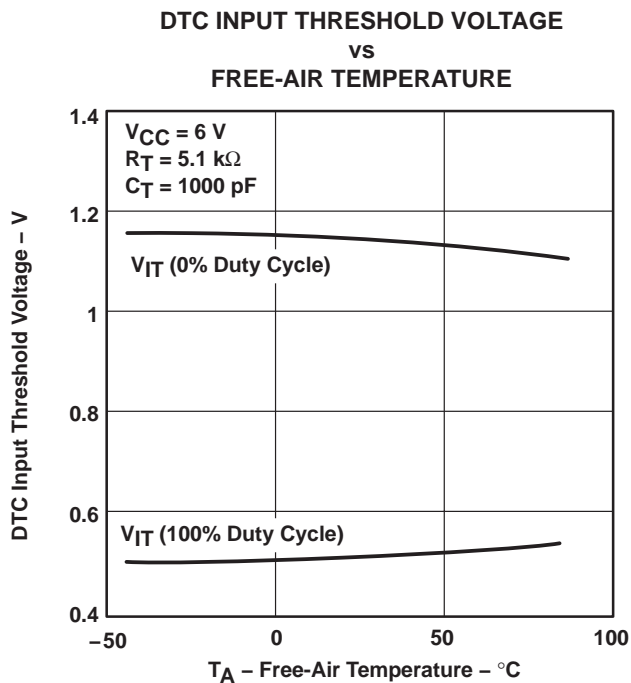

Figure 9

TL1454A, TL1454AY DUAL-CHANNEL PULSE-WIDTH-MODULATION (PWM) CONTROL CIRCUIT

SLVS423 A- MAY 2002 - REVISED SEPTEMBER 2002

TYPICAL CHARACTERISTICS



TYPICAL CHARACTERISTICS

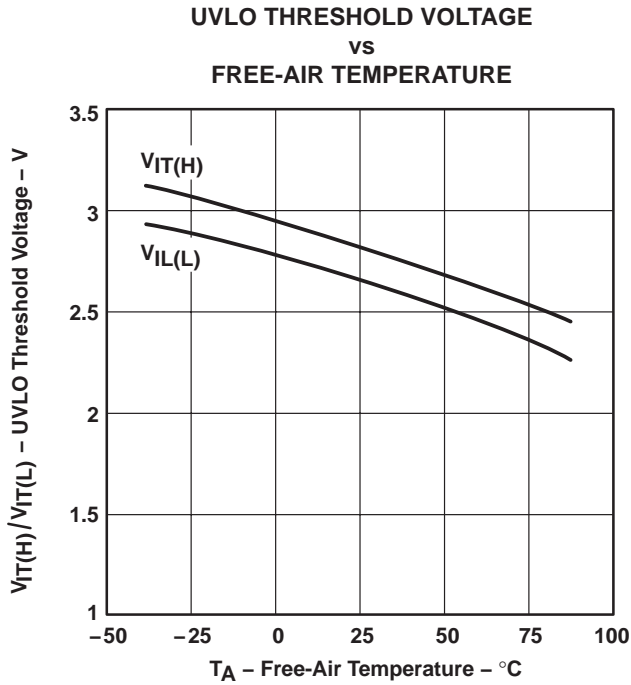

Figure 14

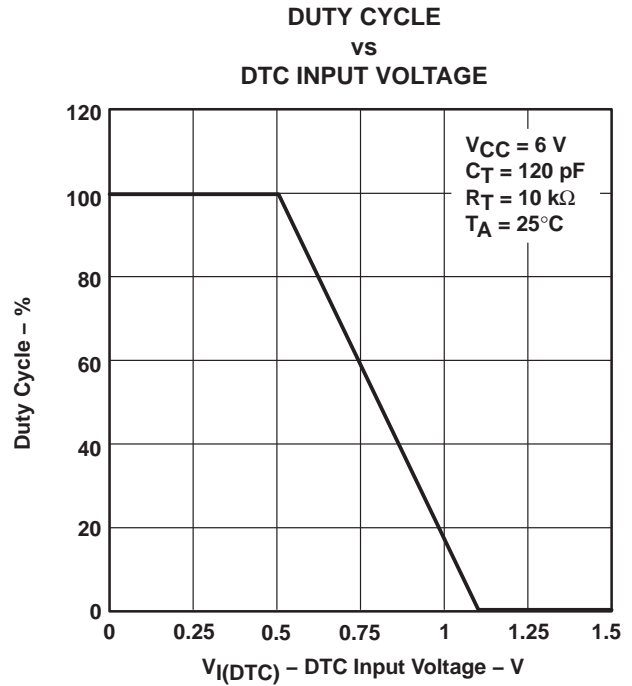

Figure 15

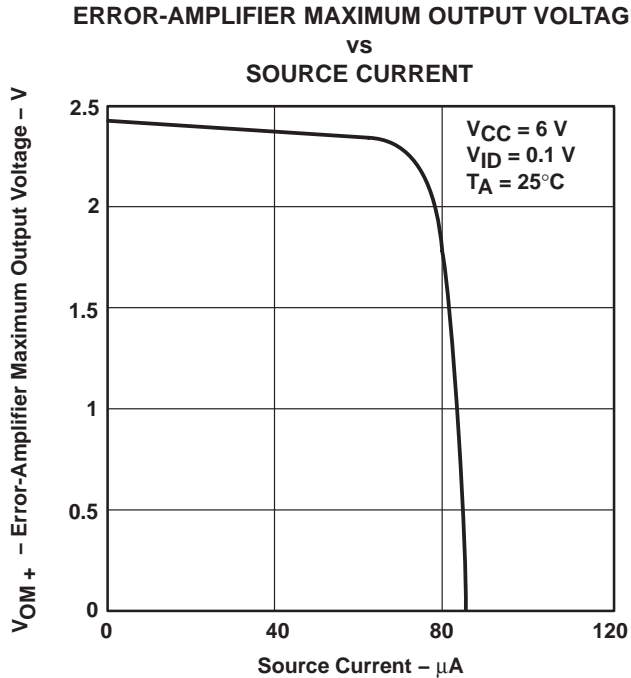

Figure 16

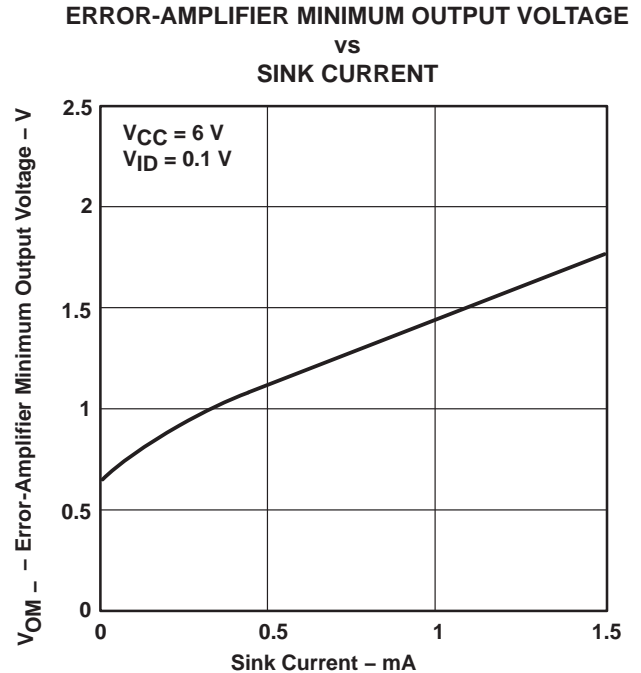
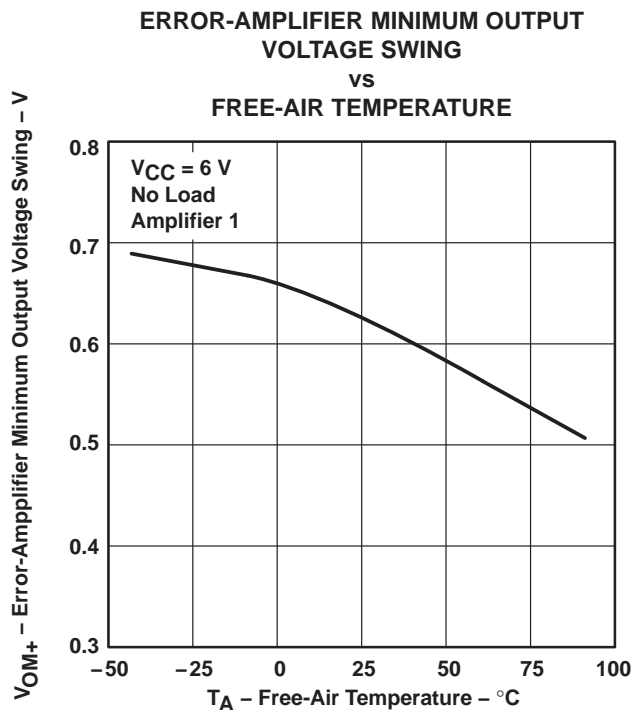
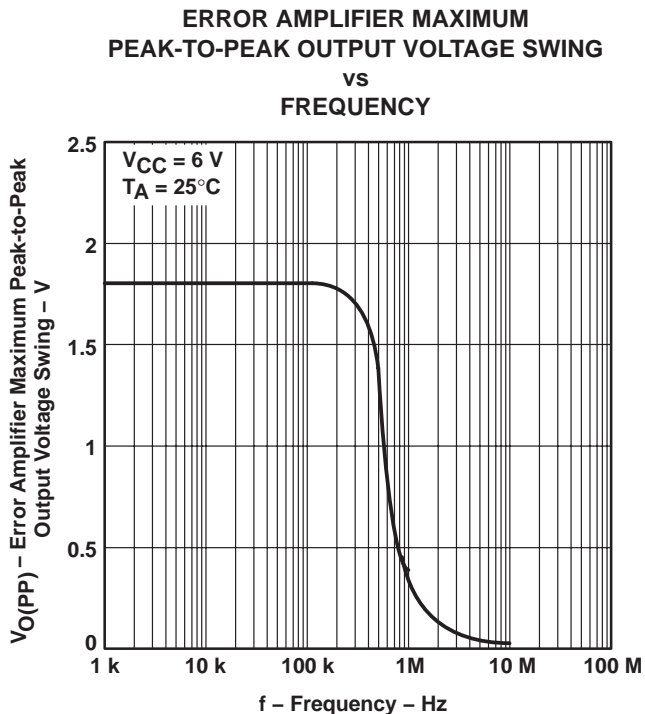

Figure 17

TL1454A, TL1454AY DUAL-CHANNEL PULSE-WIDTH-MODULATION (PWM) CONTROL CIRCUIT

SLVS423 A- MAY 2002 - REVISED SEPTEMBER 2002

TYPICAL CHARACTERISTICS



**ERROR AMPLIFIER OPEN-LOOP GAIN AND PHASE SHIFT
VS
FREQUENCY**

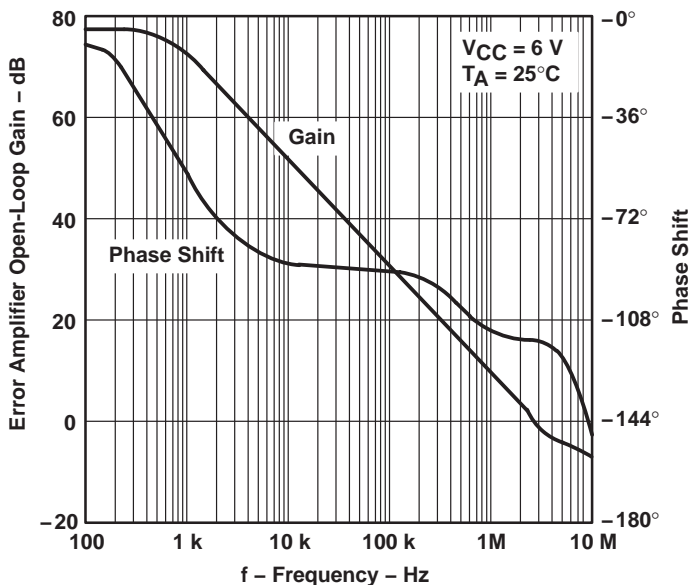

TYPICAL CHARACTERISTICS

ERROR-AMPLIFIER POSITIVE OUTPUT
 VOLTAGE SWING

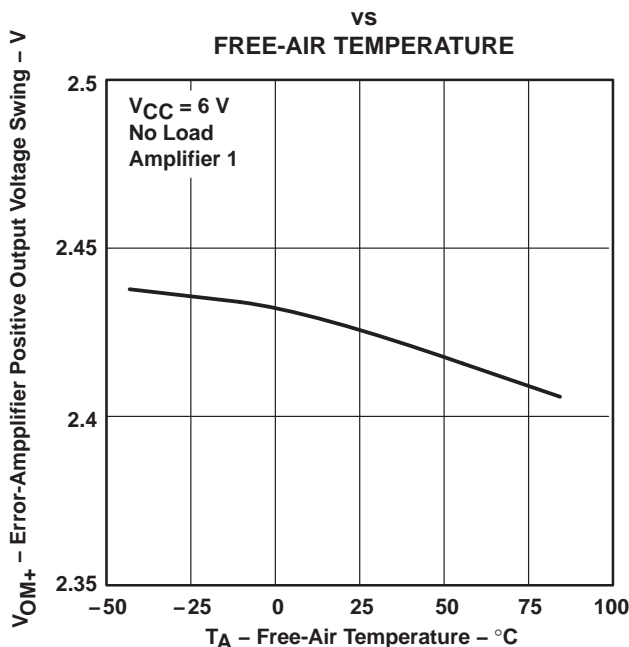

Figure 21

HIGH-LEVEL OUTPUT VOLTAGE
 vs
 OUTPUT CURRENT

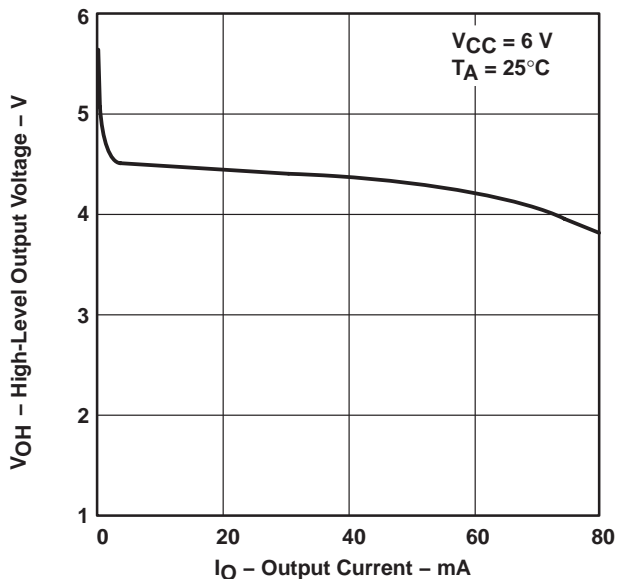

Figure 22

HIGH-LEVEL OUTPUT VOLTAGE
 vs
 FREE-AIR TEMPERATURE

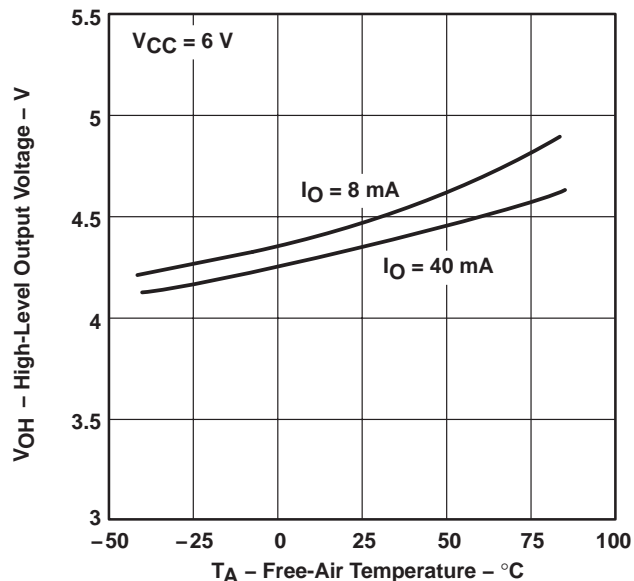
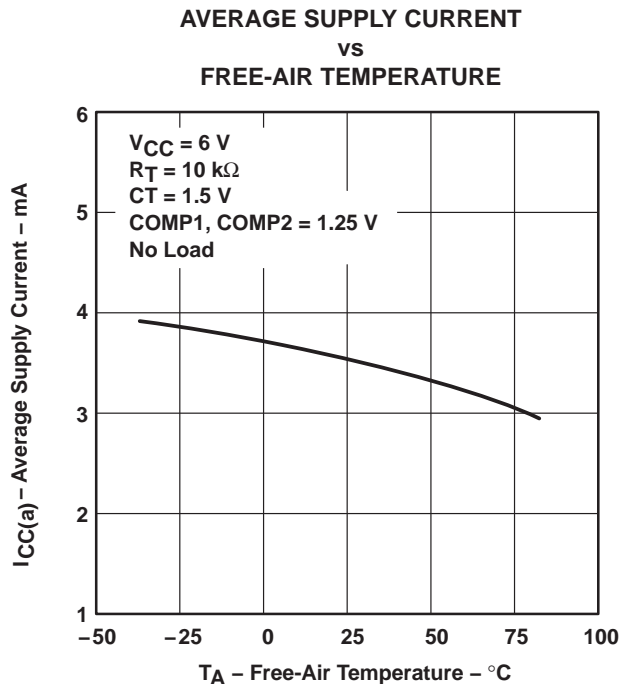
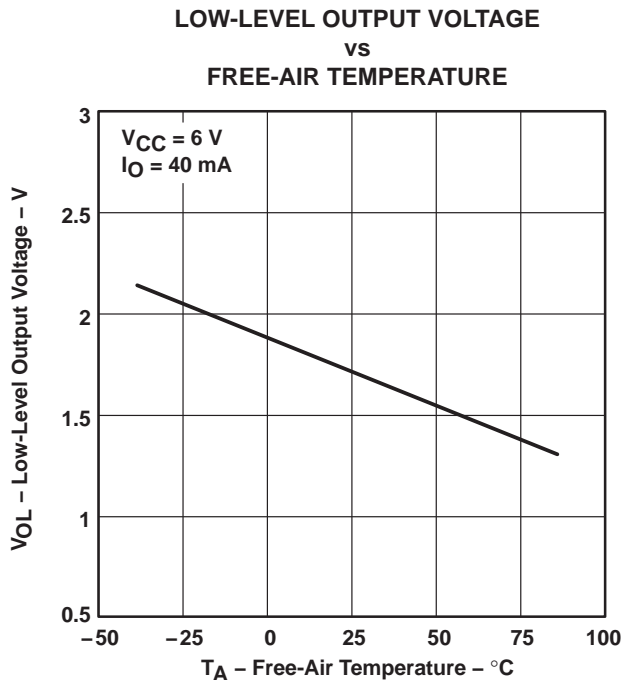
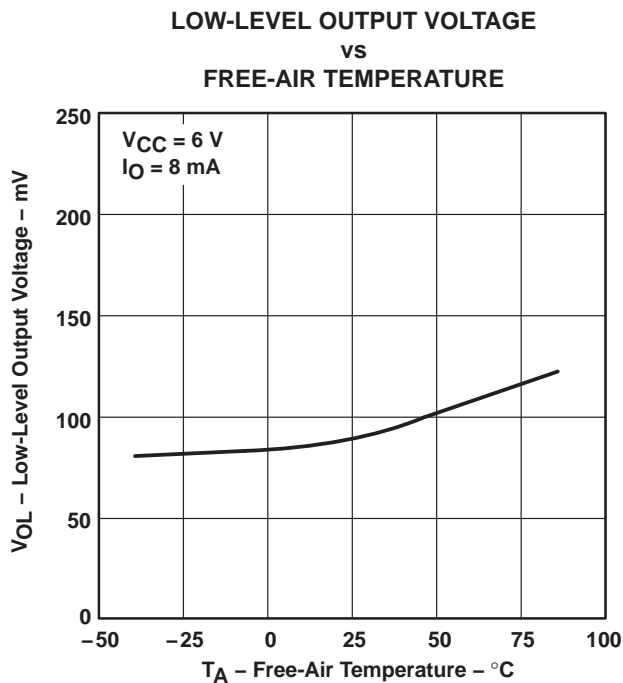
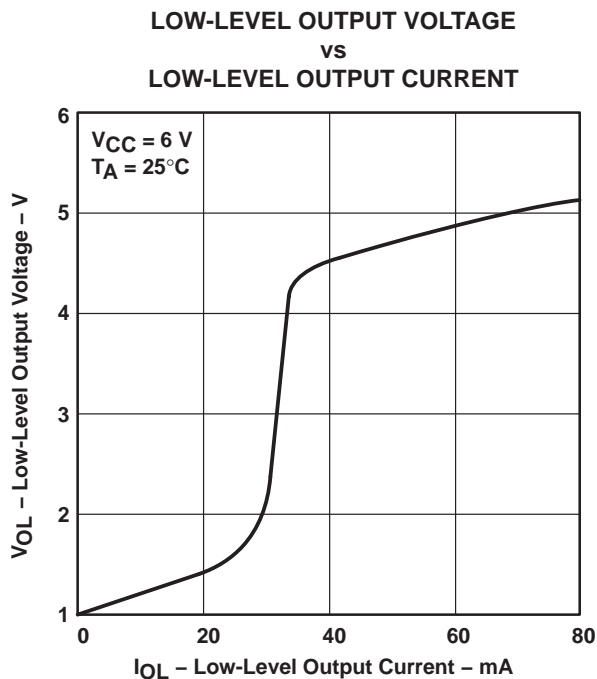

Figure 23

TL1454A, TL1454AY DUAL-CHANNEL PULSE-WIDTH-MODULATION (PWM) CONTROL CIRCUIT

SLVS423 A- MAY 2002 - REVISED SEPTEMBER 2002

TYPICAL CHARACTERISTICS



TYPICAL CHARACTERISTICS

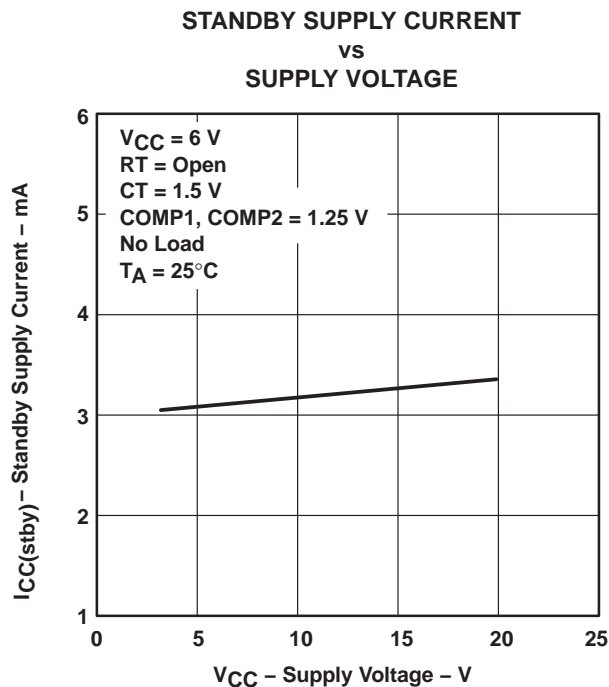

Figure 28

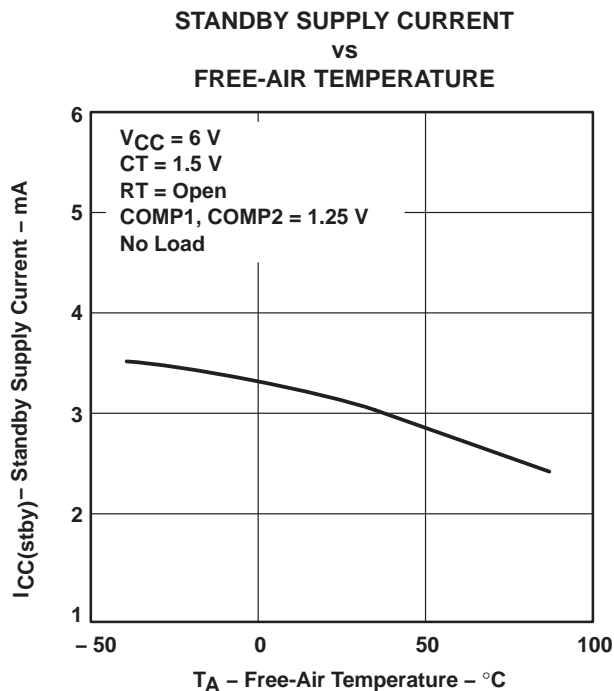

Figure 29

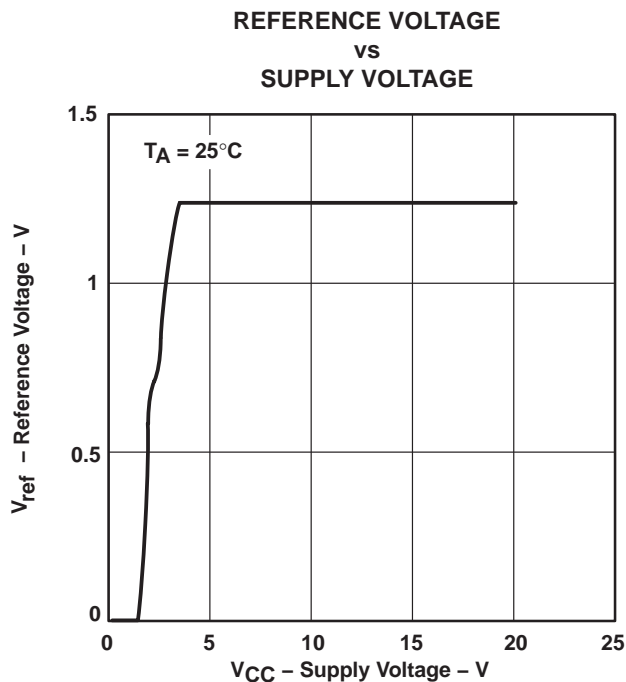

Figure 30

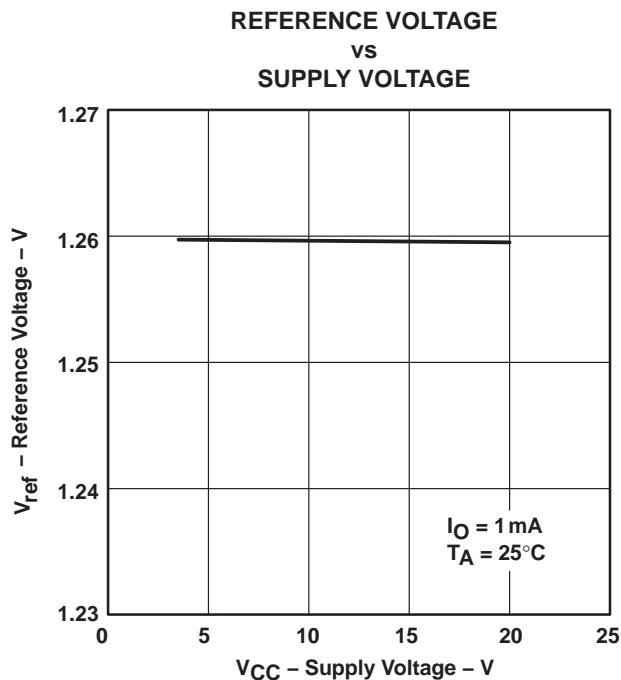

Figure 31

TL1454A, TL1454AY DUAL-CHANNEL PULSE-WIDTH-MODULATION (PWM) CONTROL CIRCUIT

SLVS423 A- MAY 2002 - REVISED SEPTEMBER 2002

TYPICAL CHARACTERISTICS

REFERENCE VOLTAGE
vs
FREE-AIR TEMPERATURE

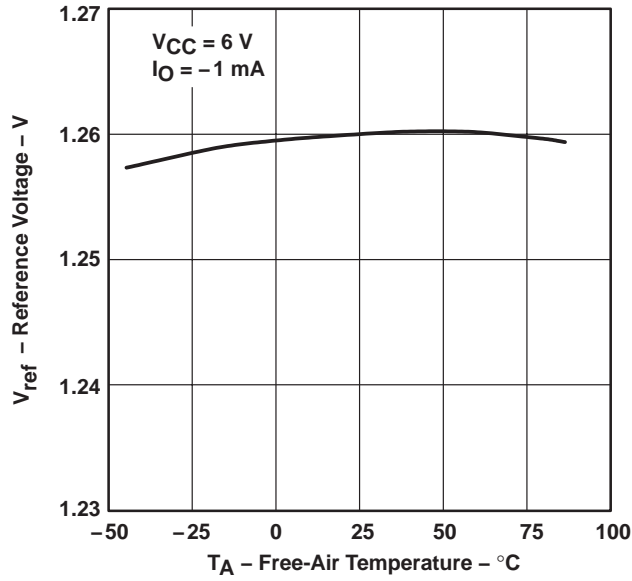

Figure 32

PACKAGING INFORMATION

| Orderable Device | Status (1) | Package Type | Package Drawing | Pins | Package Qty | Eco Plan (2) | Lead finish/ Ball material (6) | MSL Peak Temp (3) | Op Temp (°C) | Device Marking (4/5) | Samples |
|------------------|---------------|--------------|-----------------|------|-------------|-----------------|--------------------------------------|----------------------|--------------|-------------------------|-------------------------|
| TL1454ACD | ACTIVE | SOIC | D | 16 | 40 | RoHS & Green | NIPDAU | Level-1-260C-UNLIM | -20 to 85 | TL1454AC | Samples |
| TL1454ACDBR | ACTIVE | SSOP | DB | 16 | 2000 | RoHS & Green | NIPDAU | Level-1-260C-UNLIM | -20 to 85 | T1454A | Samples |
| TL1454ACN | ACTIVE | PDIP | N | 16 | 25 | RoHS & Green | NIPDAU | N / A for Pkg Type | -20 to 85 | TL1454ACN | Samples |
| TL1454ACNSR | ACTIVE | SO | NS | 16 | 2000 | RoHS & Green | NIPDAU | Level-1-260C-UNLIM | -20 to 85 | TL1454A | Samples |
| TL1454ACPW | ACTIVE | TSSOP | PW | 16 | 90 | RoHS & Green | NIPDAU | Level-1-260C-UNLIM | -20 to 85 | T1454A | Samples |
| TL1454ACPWR | ACTIVE | TSSOP | PW | 16 | 2000 | RoHS & Green | NIPDAU | Level-1-260C-UNLIM | -20 to 85 | T1454A | Samples |

(1) The marketing status values are defined as follows:

ACTIVE: Product device recommended for new designs.

LIFEBUY: TI has announced that the device will be discontinued, and a lifetime-buy period is in effect.

NRND: Not recommended for new designs. Device is in production to support existing customers, but TI does not recommend using this part in a new design.

PREVIEW: Device has been announced but is not in production. Samples may or may not be available.

OBSOLETE: TI has discontinued the production of the device.

(2) **RoHS:** TI defines "RoHS" to mean semiconductor products that are compliant with the current EU RoHS requirements for all 10 RoHS substances, including the requirement that RoHS substance do not exceed 0.1% by weight in homogeneous materials. Where designed to be soldered at high temperatures, "RoHS" products are suitable for use in specified lead-free processes. TI may reference these types of products as "Pb-Free".

RoHS Exempt: TI defines "RoHS Exempt" to mean products that contain lead but are compliant with EU RoHS pursuant to a specific EU RoHS exemption.

Green: TI defines "Green" to mean the content of Chlorine (Cl) and Bromine (Br) based flame retardants meet JS709B low halogen requirements of <=1000ppm threshold. Antimony trioxide based flame retardants must also meet the <=1000ppm threshold requirement.

(3) MSL, Peak Temp. - The Moisture Sensitivity Level rating according to the JEDEC industry standard classifications, and peak solder temperature.

(4) There may be additional marking, which relates to the logo, the lot trace code information, or the environmental category on the device.

(5) Multiple Device Markings will be inside parentheses. Only one Device Marking contained in parentheses and separated by a "-" will appear on a device. If a line is indented then it is a continuation of the previous line and the two combined represent the entire Device Marking for that device.

(6) Lead finish/Ball material - Orderable Devices may have multiple material finish options. Finish options are separated by a vertical ruled line. Lead finish/Ball material values may wrap to two lines if the finish value exceeds the maximum column width.

Important Information and Disclaimer: The information provided on this page represents TI's knowledge and belief as of the date that it is provided. TI bases its knowledge and belief on information provided by third parties, and makes no representation or warranty as to the accuracy of such information. Efforts are underway to better integrate information from third parties. TI has taken and continues to take reasonable steps to provide representative and accurate information but may not have conducted destructive testing or chemical analysis on incoming materials and chemicals. TI and TI suppliers consider certain information to be proprietary, and thus CAS numbers and other limited information may not be available for release.

In no event shall TI's liability arising out of such information exceed the total purchase price of the TI part(s) at issue in this document sold by TI to Customer on an annual basis.

TAPE AND REEL INFORMATION



QUADRANT ASSIGNMENTS FOR PIN 1 ORIENTATION IN TAPE



*All dimensions are nominal

| Device | Package Type | Package Drawing | Pins | SPQ | Reel Diameter (mm) | Reel Width W1 (mm) | A0 (mm) | B0 (mm) | K0 (mm) | P1 (mm) | W (mm) | Pin1 Quadrant |
|-------------|--------------|-----------------|------|------|--------------------|--------------------|---------|---------|---------|---------|--------|---------------|
| TL1454ACDBR | SSOP | DB | 16 | 2000 | 330.0 | 16.4 | 8.35 | 6.6 | 2.5 | 12.0 | 16.0 | Q1 |
| TL1454ACNSR | SO | NS | 16 | 2000 | 330.0 | 16.4 | 8.1 | 10.4 | 2.5 | 12.0 | 16.0 | Q1 |
| TL1454ACPWR | TSSOP | PW | 16 | 2000 | 330.0 | 12.4 | 6.9 | 5.6 | 1.6 | 8.0 | 12.0 | Q1 |

TAPE AND REEL BOX DIMENSIONS



*All dimensions are nominal

| Device | Package Type | Package Drawing | Pins | SPQ | Length (mm) | Width (mm) | Height (mm) |
|-------------|--------------|-----------------|------|------|-------------|------------|-------------|
| TL1454ACDBR | SSOP | DB | 16 | 2000 | 356.0 | 356.0 | 35.0 |
| TL1454ACNSR | SO | NS | 16 | 2000 | 356.0 | 356.0 | 35.0 |
| TL1454ACPWR | TSSOP | PW | 16 | 2000 | 356.0 | 356.0 | 35.0 |

TUBE

*All dimensions are nominal

| Device | Package Name | Package Type | Pins | SPQ | L (mm) | W (mm) | T (μm) | B (mm) |
|------------|--------------|--------------|------|-----|--------|--------|--------|--------|
| TL1454ACD | D | SOIC | 16 | 40 | 507 | 8 | 3940 | 4.32 |
| TL1454ACD | D | SOIC | 16 | 40 | 505.46 | 6.76 | 3810 | 4 |
| TL1454ACN | N | PDIP | 16 | 25 | 506 | 13.97 | 11230 | 4.32 |
| TL1454ACPW | PW | TSSOP | 16 | 90 | 530 | 10.2 | 3600 | 3.5 |

IMPORTANT NOTICE AND DISCLAIMER

TI PROVIDES TECHNICAL AND RELIABILITY DATA (INCLUDING DATA SHEETS), DESIGN RESOURCES (INCLUDING REFERENCE DESIGNS), APPLICATION OR OTHER DESIGN ADVICE, WEB TOOLS, SAFETY INFORMATION, AND OTHER RESOURCES "AS IS" AND WITH ALL FAULTS, AND DISCLAIMS ALL WARRANTIES, EXPRESS AND IMPLIED, INCLUDING WITHOUT LIMITATION ANY IMPLIED WARRANTIES OF MERCHANTABILITY, FITNESS FOR A PARTICULAR PURPOSE OR NON-INFRINGEMENT OF THIRD PARTY INTELLECTUAL PROPERTY RIGHTS.

These resources are intended for skilled developers designing with TI products. You are solely responsible for (1) selecting the appropriate TI products for your application, (2) designing, validating and testing your application, and (3) ensuring your application meets applicable standards, and any other safety, security, regulatory or other requirements.

These resources are subject to change without notice. TI grants you permission to use these resources only for development of an application that uses the TI products described in the resource. Other reproduction and display of these resources is prohibited. No license is granted to any other TI intellectual property right or to any third party intellectual property right. TI disclaims responsibility for, and you will fully indemnify TI and its representatives against, any claims, damages, costs, losses, and liabilities arising out of your use of these resources.

TI's products are provided subject to [TI's Terms of Sale](#) or other applicable terms available either on ti.com or provided in conjunction with such TI products. TI's provision of these resources does not expand or otherwise alter TI's applicable warranties or warranty disclaimers for TI products.

TI objects to and rejects any additional or different terms you may have proposed.

Mailing Address: Texas Instruments, Post Office Box 655303, Dallas, Texas 75265
Copyright © 2022, Texas Instruments Incorporated