



austriamicrosystems AG

is now

ams AG

The technical content of this austriamicrosystems datasheet is still valid.

Contact information:

Headquarters:

ams AG

Tobelbaderstrasse 30

8141 Unterpremstaetten, Austria

Tel: +43 (0) 3136 500 0

e-Mail: ams_sales@ams.com

Please visit our website at www.ams.com

AS1118

64 LED Driver for Mobile Applications with Error Detection

1 General Description

The AS1118 is a compact LED driver for 64 single LEDs or 8 digits of 7-segments. The devices can be programmed via an SPI compatible 3-wire interface. Every segment can be individually addressed and updated separately. Only one external resistor (RSET) is required to set the current. LED brightness can be controlled by analog or digital means. The devices include an integrated BCD code-B/HEX decoder, multiplex scan circuitry, segment and display drivers, and a 64-bit memory. Internal memory stores the shift register settings, eliminating the need for continuous device reprogramming.

Table 1. Available Products

Devices	RESET Input	Interfaces
AS1115	no	I ² C
AS1116	no	SPI
AS1117	yes	I ² C
AS1118	yes	SPI

Additionally the AS1118 offers a detailed error diagnostic mode for easy and fast production testing in critical applications. The AS1118 features a low shutdown current of typically 200nA, and an operational current of typically 350µA. The number of digits can be programmed, the devices can be reset by software, and an external clock is also supported. The device is available in a TQFN(4x4)-24 package.

Figure 1. AS1118 - Typical Application Diagram

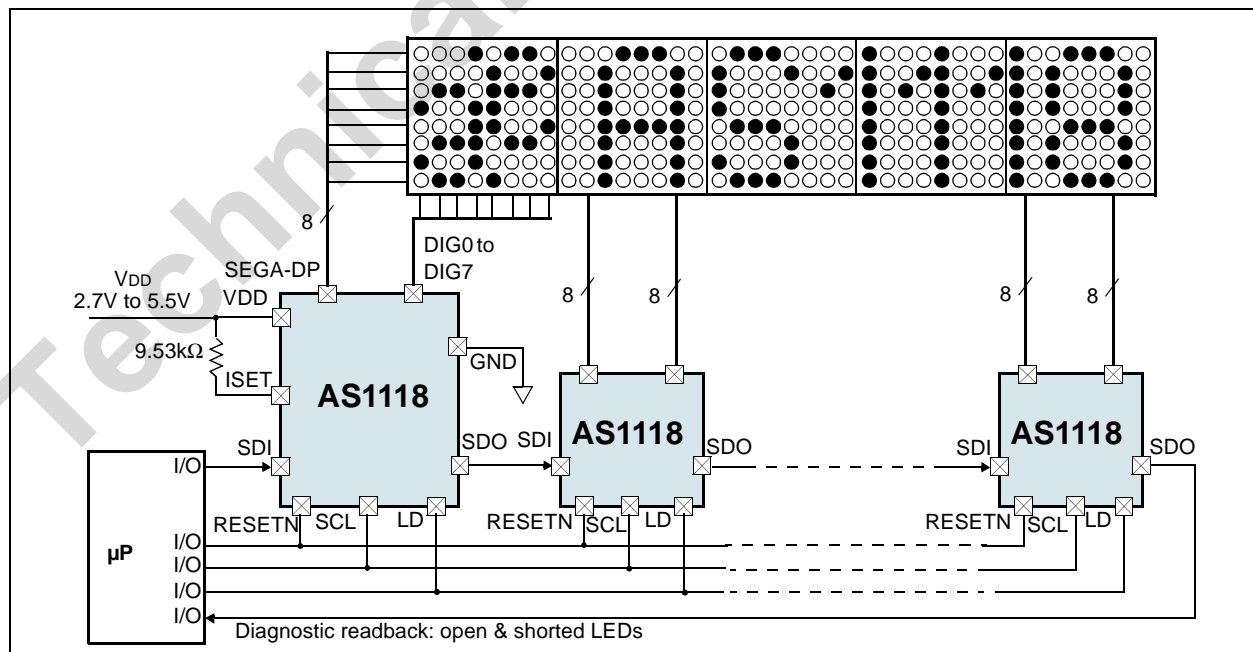

2 Key Features

- 10MHz SPI-Compatible Interface
- Open and Shorted LED Error Detection - Global or Individual Error Detection
- Hexadecimal- or BCD-Code for 7-Segment Displays
- 200nA Low-Power Shutdown Current (typ; data retained)
- Individual Digit Brightness Control
- Digital and Analog Brightness Control
- Display Blanked on Power-Up
- Drive Common-Cathode LED Displays
- Supply Voltage Range: 2.7V to 5.5V
- Software and Hardware Reset
- Optional External Clock
- Package: TQFN(4x4)-24

3 Applications

The AS1118 is ideal for seven-segment or dot matrix displays in mobile applications, public information displays at subway, train or bus stations, at airports and also at displays in public transportation like buses or trains, personal electronic and toys.

4 Pinout

Pin Assignments

Figure 2. Pin Assignments (Top View)

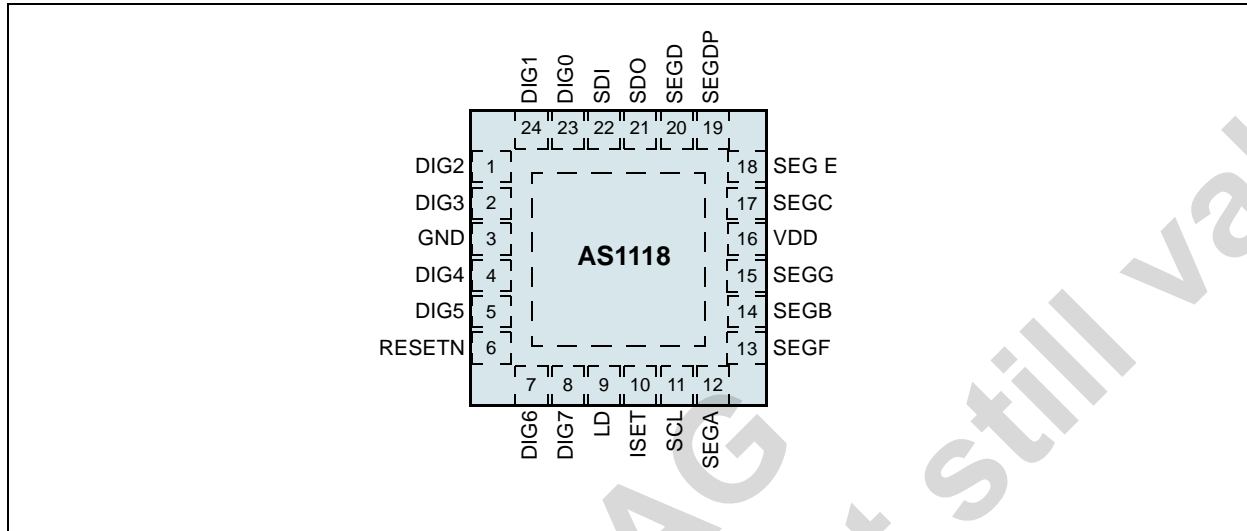

Pin Descriptions

Table 2. Pin Descriptions

Pin Name	TQFN(4x4)-24	Description
SDI	22	Serial-Data Input. Data is loaded into the internal 16-bit shift register on the rising edge of pin SCL.
DIG0:DIG7	1, 2, 4, 5, 7, 8, 23, 24	Digit Drive Lines. Eight digit drive lines that sink current from the display cathode.
GND	3	Ground.
LD	9	Load. Serial Data is loaded into the shift register while this pin is low. The last 16 bits of serial data are latched on the rising edge of this pin.
RESETN	6	Reset Input. Pull this pin to low to reset all registers (set to default values) and to put the device into shutdown.
ISET	10	Set Segment Current. Connect to VDD or a reference voltage through RSET to set the peak segment current (see Selecting RSET Resistor Value and Using External Drivers on page 15).
SCL	11	Serial-Clock Input. 10MHz maximum rate. Data is shifted into the internal shift register on the rising edge of this pin. Data is clocked out of pin SDO on the rising edge of this pin.
SEGA:SEGG, SEGDP	12-15, 17-20	Seven Segment and Decimal Point Drive Lines. 8 seven-segment drives and decimal point drive that source current to the display.
VDD	16	Positive Supply Voltage. Connect to +2.7V to +5.5V supply. Bypass this pin to GND with a 10µF and a 0.1µF capacitor to avoid power supply ripple.
SDO	21	Serial-Data Output. The data into pin SDI is valid at pin SDO 16 clock cycles later. This pin is used to daisy-chain several devices and is never high-impedance.
	Exposed Pad	Exposed Pad. This pin also functions as a heat sink. Solder it to a large pad or to the circuit-board ground plane to maximize power dissipation.

5 Absolute Maximum Ratings

Stresses beyond those listed in [Table 3](#) may cause permanent damage to the device. These are stress ratings only, and functional operation of the device at these or any other conditions beyond those indicated in [Section 6 Electrical Characteristics on page 4](#) is not implied. Exposure to absolute maximum rating conditions for extended periods may affect device reliability.

Table 3. Absolute Maximum Ratings

Parameter		Min	Max	Units	Notes
Electrical Parameters					
Input Voltage Range	V _{DD} to GND	-0.3	7	V	
	All other pins to GND	-0.3	7 or V _{DD} + 0.3	V	
Current	DIG0:DIG7 Sink Current		500	mA	
	SEGA:SEGG, SEGDP		100	mA	
Input Current (latch-up immunity)		±100		mA	Norm: JEDEC 78
Electrostatic Discharge					
Electrostatic Discharge	Digital outputs		1000	V	Norm: MIL 833 E method 3015
	All other pins		1000	V	
Thermal Information					
Thermal Resistance Θ_{JA}			30.5	°C/W	on PCB
Temperature Ranges and Storage Conditions					
Junction Temperature			+150	°C	
Storage Temperature		-55	+150	°C	
Package Body Temperature			+260	°C	The reflow peak soldering temperature (body temperature) specified is in accordance with IPC/JEDEC J-STD-020 "Moisture/Reflow Sensitivity Classification for Non-Hermetic Solid State Surface Mount Devices". The lead finish for Pb-free leaded packages is matte tin (100% Sn).
Humidity non-condensing		5	85	%	
Moisture Sensitive Level		3		%	Represents a max. floor life time of 168h

6 Electrical Characteristics

$V_{DD} = 2.7V$ to $5.5V$, $R_{SET} = 9.53k\Omega$, $T_{AMB} = -40^{\circ}C$ to $+85^{\circ}C$, *typ. values @ $T_{AMB} = +25^{\circ}C$ and $V_{DD} = 5.0V$ (unless otherwise specified).*

Table 4. Electrical Characteristics

Symbol	Parameter	Conditions	Min	Typ	Max	Unit
V _{DD}	Operating Supply Voltage		2.7		5.5	V
I _{DDSD}	Shutdown Supply Current	All digital inputs at V _{DD} or GND, T _{AMB} = +25°C		0.2	2	μA
I _{DD}	Operating Supply Current	R _{SET} = open circuit.		0.35	0.6	mA
		All segments and decimal point on; I _{SEG} = -40mA.		335		
f _{OSC}	Display Scan Rate	8 digits scanned	0.6	0.8	1.2	kHz
I _{DIGIT}	Digit Drive Sink Current	V _{OUT} = 0.65V	320			mA
I _{SEG}	Segment Drive Source Current	V _{DD} = 5.0V, V _{OUT} = (V _{DD} - 1V)	-37	-42	-47	mA
ΔI _{SEG}	Segment Drive Current Matching		3			%
I _{SEG}	Segment Drive Source Current	Average Current			47	mA

Table 5. Logic Inputs/Outputs Characteristics

Symbol	Parameter	Conditions	Min	Typ	Max	Unit
I _{IH} , I _{IL}	Input Current SDI, SCL, LD	V _{IN} = 0V or V _{DD}	-1		1	μA
V _{IH}	Logic High Input Voltage SDI, SCL, LD, RESETN		1.26			V
V _{IL}	Logic Low Input Voltage SDI, SCL, LD, RESETN				0.54	V
V _{OH}	Output High Voltage	SDO, I _{SOURCE} = -1mA, V _{DD} = 5.0V	V _{DD} - 1			V
		SDO, I _{SOURCE} = -1mA, V _{DD} = 3.0V	V _{DD} - 0.5			
V _{OL}	Output Low Voltage	SDO, I _{SINK} = 1mA			0.4	V
ΔV _I	Hysteresis Voltage	SDI, SCL, LD		1		V
	Open Detection Level Threshold		0.7x V _{DD}	0.75x V _{DD}	0.8x V _{DD}	V
	Short Detection Level Threshold		0.05x V _{DD}	0.1x V _{DD}	0.15x V _{DD}	V

Table 6. SPI Timing Characteristics

Symbol	Parameter	Conditions	Min	Typ	Max	Unit
t _{CP}	SCL Clock Period		100			ns
t _{CH}	SCL Pulse Width High		20			ns
t _{CL}	SCL Pulse Width Low		20			ns
t _{CSS}	LD to SCL Rise Setup Time		25			ns
t _{CSH}	SCL Rise to LD Rise Hold Time		10			ns
t _{DS}	SDI Setup Time		0			ns
t _{DH}	SDI Hold Time		5			ns
t _{DO}	Output Data Propagation Delay	C _{LOAD} = 50pF			25	ns
t _{LDCK}	LD Rising Edge to SCL Rising Edge		20			ns
t _{CSW}	Minimum LD Pulse High		20			ns
t _{DSPD}	Data-to-Segment Delay				2.25	ms

See Figure 18 on page 8 for more information.

7 Typical Operating Characteristics

RSET = 9.53kΩ, VRset = VDD;

Figure 3. Display Scan Rate vs. Supply Voltage;

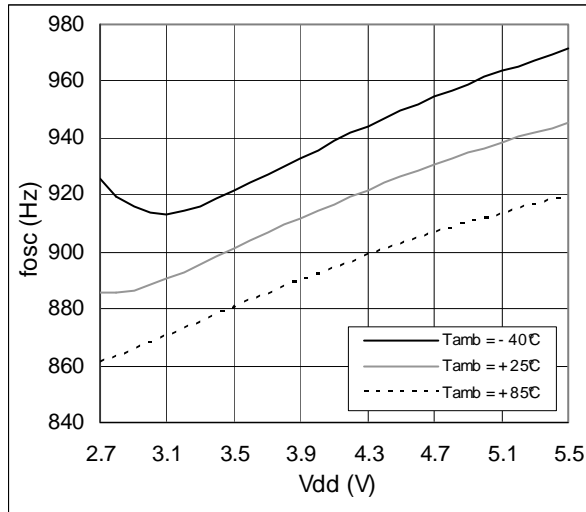

Figure 4. Display Scan Rate vs. Temperature;

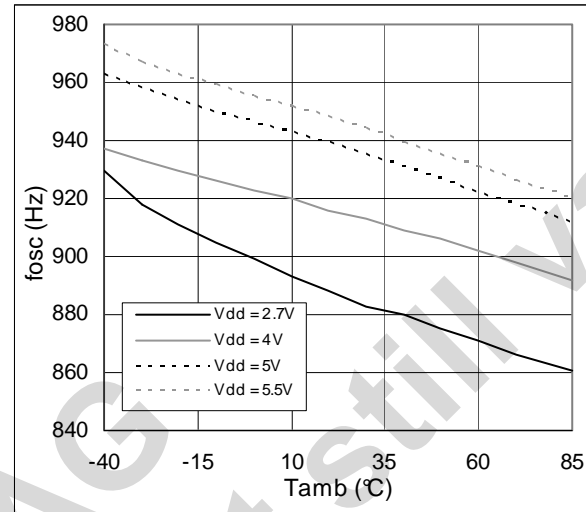

Figure 5. Segment Current vs. Temperature;

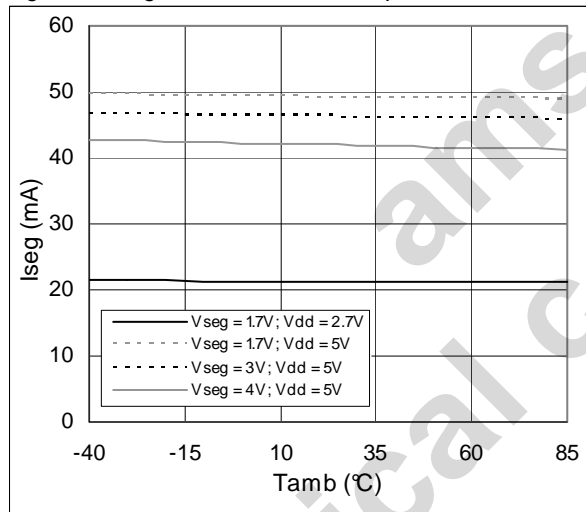

Figure 6. Segment Current vs. RSET;

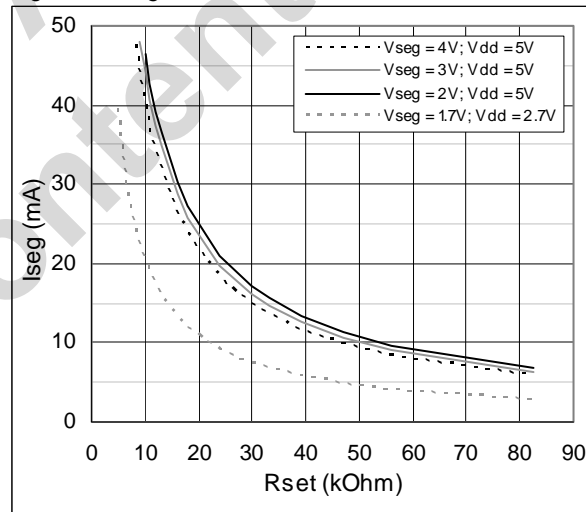

Figure 7. Segment Current vs. Supply Voltage;

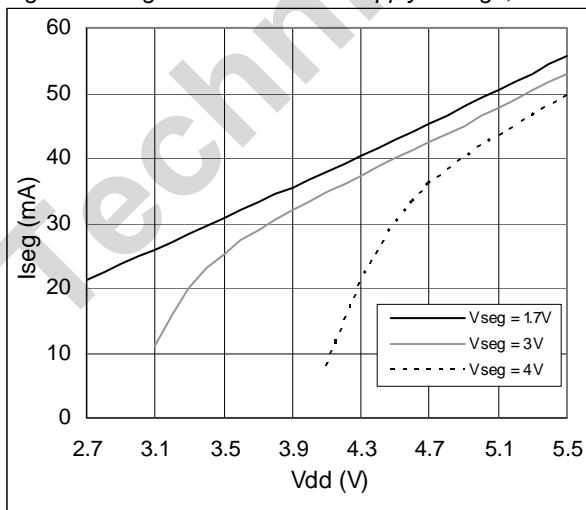

Figure 8. Segment Current vs. VDD; VRset = 2.8V

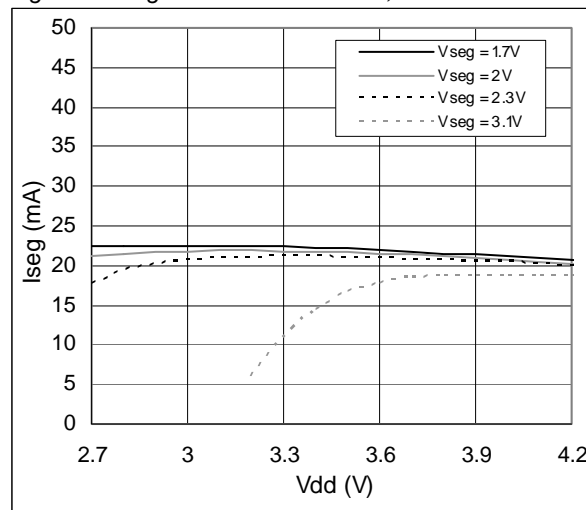

Figure 9. V_{DIGIT} vs. I_{DIGIT}

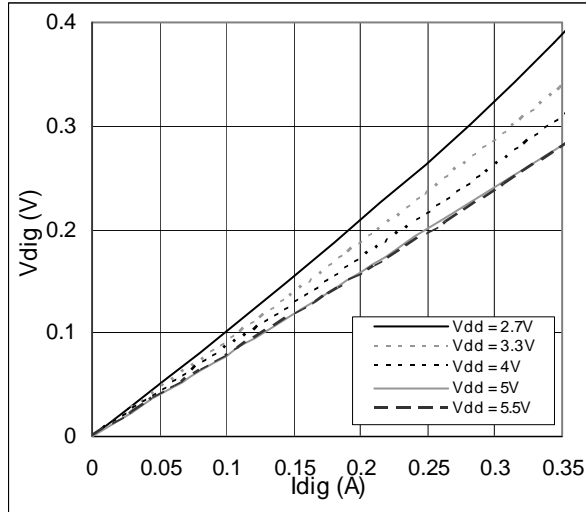

Figure 10. Input High Level vs. Supply Voltage

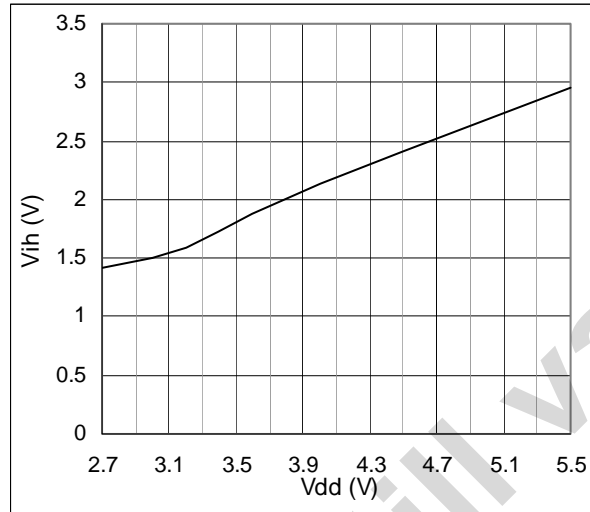

Figure 11. I_{SEG} vs. V_{SEG} ; $V_{DD} = 5V$

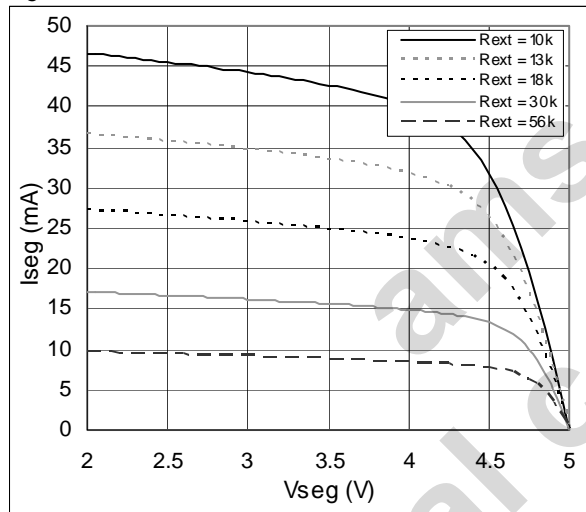

Figure 12. I_{SEG} vs. V_{SEG} ; $V_{DD} = 4V$

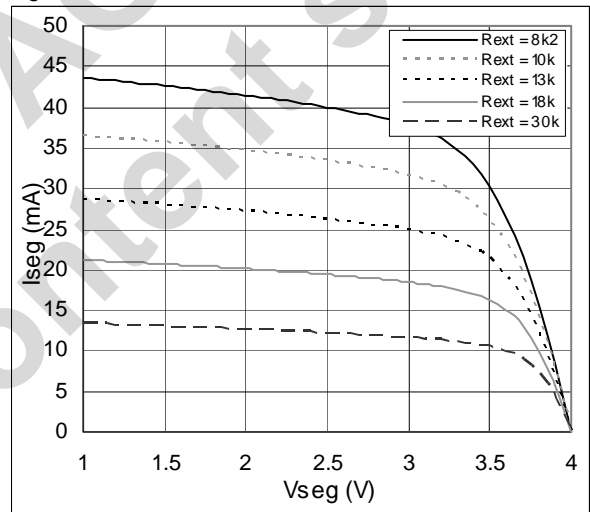

Figure 13. I_{SEG} vs. V_{SEG} ; $V_{DD} = 3.3V$

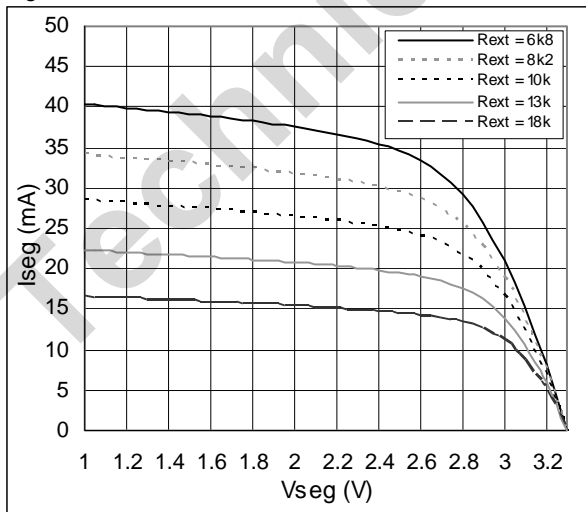
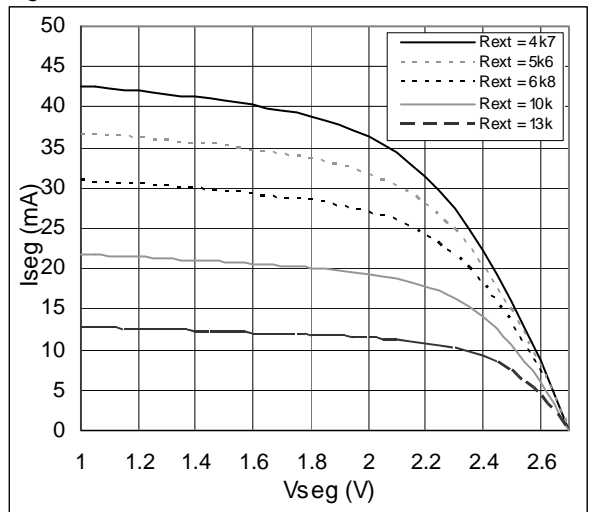

Figure 14. I_{SEG} vs. V_{SEG} ; $V_{DD} = 2.7V$



8 Detailed Description

Block Diagram

Figure 15. AS1118 - Block Diagram

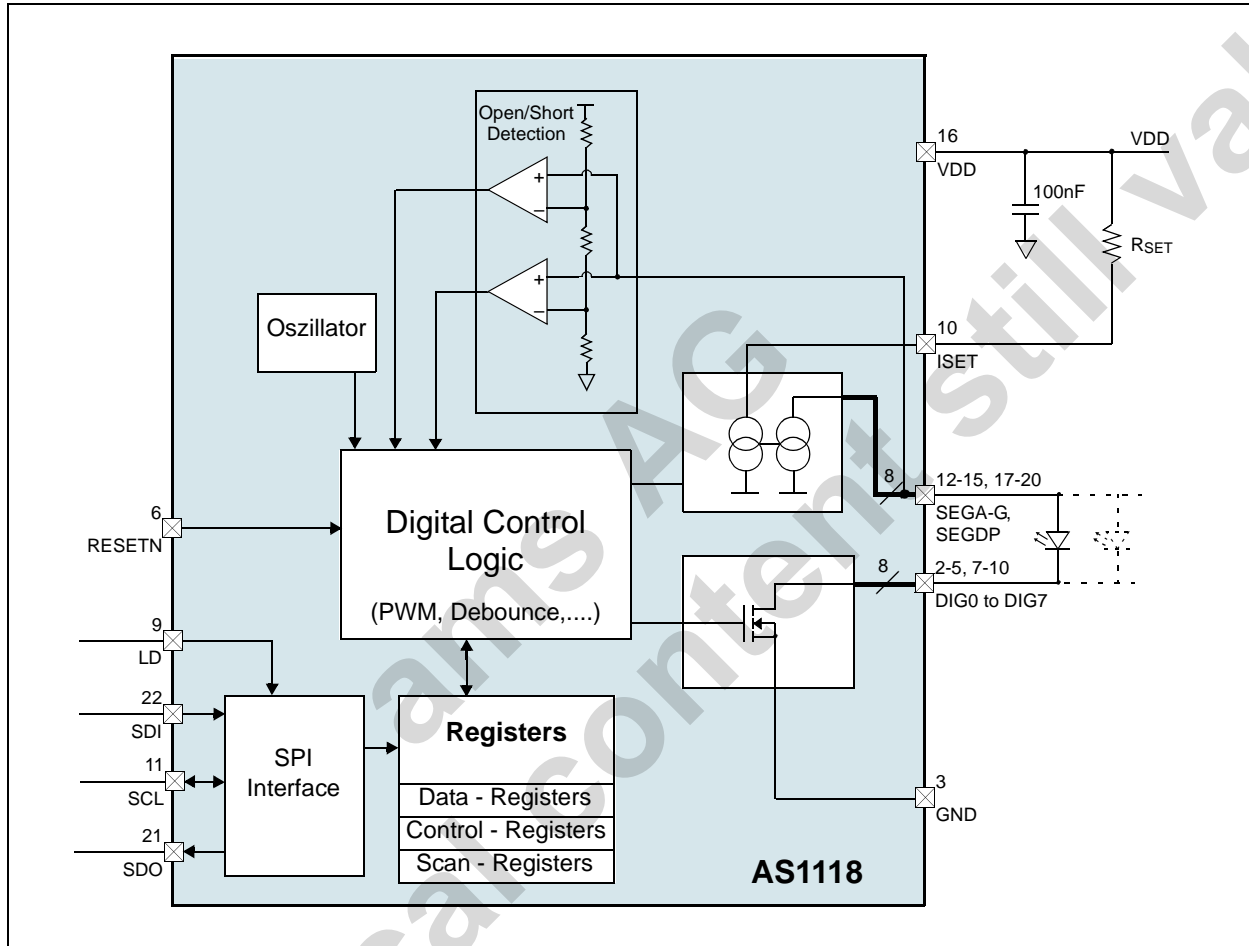
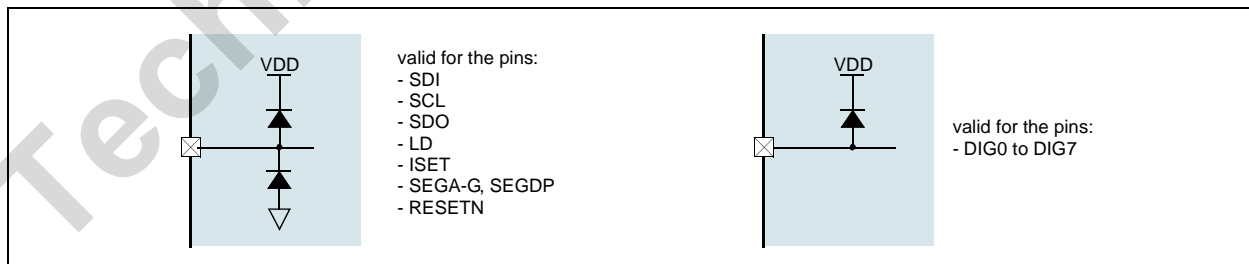

Figure 16. ESD Structure



Serial-Addressing Format

The AS1118 contains a 16bit SPI interface to access the internal data and control registers of the device (see [Digit- and Control-Registers on page 9](#)). The SPI interface is driven with the rising edge of SCL. A falling edge on LD signal indicates the beginning of an access on the SPI interface, the rising edge on LD determines an access on SPI. An access must consist of exactly 16bits for write operation and 8bits for read operation. Timing restrictions on the SPI interface pins are defined in [Figure 18](#).

[Table 7](#) shows the structure of the 16bit command word for writing data, [Table 8](#) the 8bit command word for read operation.

D0 (write operation) / D8 (read operation) is the first bit to shift into the SPI interface after the falling edge of LD, is the last bit to write to SPI before rising edge of LD.

At a read operation an 8bit operation is executed. At the first rising edge of SCL after the rising edge of LD D7 of addressed register is written to SDO pin. At the next rising edge of SCL D6 is written to SDO pin. LD must be kept high during reading data from a internal data or control register of AS1118.

Table 7. 16-Bit Serial Data Format

D0	D1	D2	D3	D4	D5	D6	D7	D8	D9	D10	D11	D12	D13	D14	D15
Data						MSB		Register Address (see Table 8)					0	R/W	X
LSB															

Figure 17. Read operation

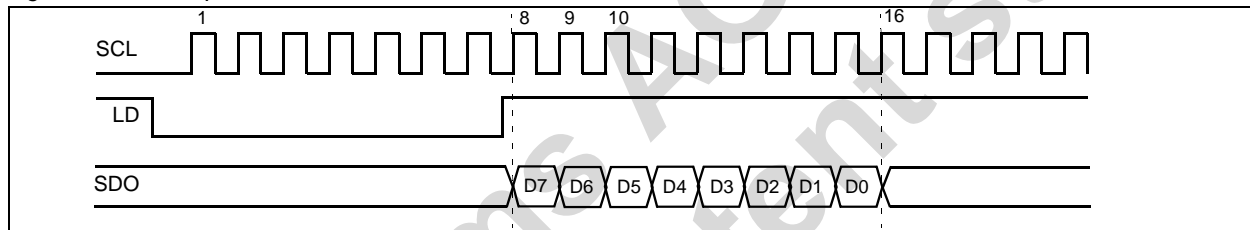
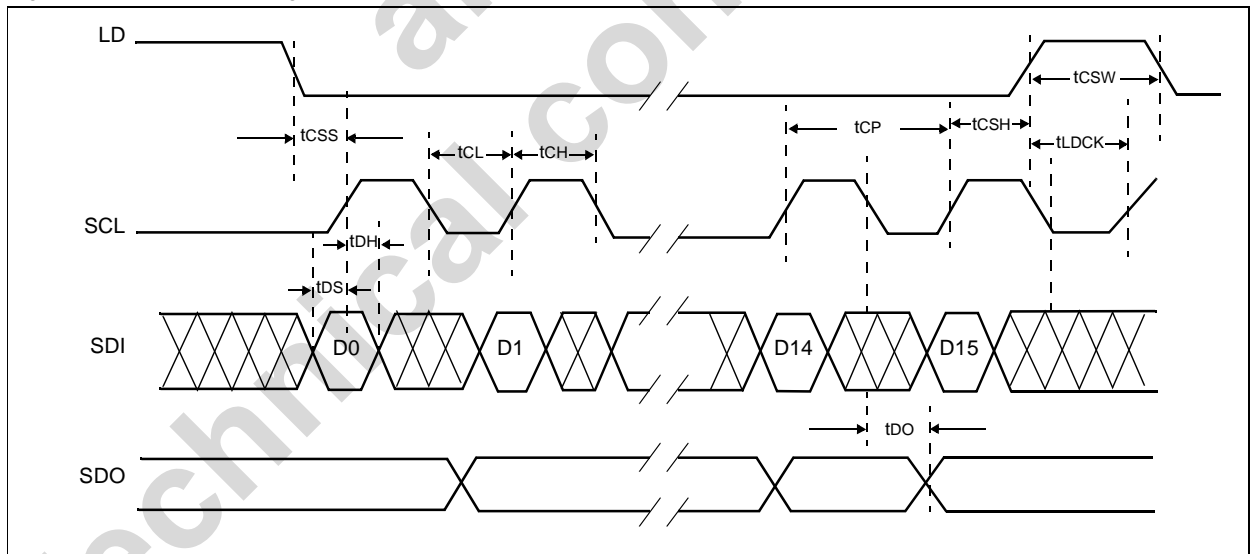

Figure 18. Interface Timing



Initial Power-Up

On initial power-up, the AS1118 registers are reset to their default values, the display is blanked, and the device goes into shutdown mode. At this time, all registers should be programmed for normal operation.

Note: The default settings enable only scanning of one digit; the internal decoder is disabled and the Intensity Control Register (see [page 13](#)) is set to the minimum values.

Shutdown Mode

The AS1118 devices feature a shutdown mode, where they consume only 200nA (typ) current. Shutdown mode is entered via a write to the Shutdown Register (see [Table 9](#)) or via pulling the pin RESTEN to logic low. When pin RESETN is set to logic low an according write to the Shutdown Register is done internally.

For the AS1118, at that point, all segment current sources and digital drivers are switched off, so that all segments are blanked. During shutdown mode the Digit-Registers maintain their data.

Note: When pin RESETN is pulled to logic high again, a write to the Shutdown Register is necessary to leave the shutdown mode.

Shutdown mode can either be used as a means to reduce power consumption or for generating a flashing display (repeatedly entering and leaving shutdown mode). For minimum supply current in shutdown mode, logic input should be at GND or VDD (CMOS logic level).

When entering or leaving shutdown mode, the Feature Register is reset to its default values (all 0s) when Shutdown Register bit D7 (page 10) = 0.

Note: When Shutdown Register bit D7 = 1, the Feature Register is left unchanged when entering or leaving shutdown mode. If the AS1118 is used with an external clock, Shutdown Register bit D7 should be set to 1 when writing to the Shutdown Register.

Digit- and Control-Registers

The AS1118 devices contain 8 Digit-Registers, 11 control-registers and 8 diagnostic-registers, which are listed in [Table 8](#). All registers are selected using a 8-bit address word, and communication is done via the serial interface.

- Digit Registers – These registers are realized with an on-chip 64-bit memory. Each digit can be controlled directly without rewriting the whole register contents.
- Control Registers – These registers consist of decode mode, display intensity, number of scanned digits, shutdown, display test and features selection registers.

Table 8. Register Address Map

Type	Register	Address								Page	
		D15	D14	D13	D12	D11	D10	D9	D8		D7:D0
	No-Op	X	0	0	0	0	0	0	0		14
Digit Register	Digit 0	X	0	0	0	0	0	0	1	(see Table 11 on page 11, Table 12 on page 11 and Table 13 on page 11)	N/A
	Digit 1	X	0	0	0	0	0	1	0		N/A
	Digit 2	X	0	0	0	0	0	1	1		N/A
	Digit 3	X	0	0	0	0	1	0	0		N/A
	Digit 4	X	0	0	0	0	1	0	1		N/A
	Digit 5	X	0	0	0	0	1	1	0		N/A
	Digit 6	X	0	0	0	0	1	1	1		N/A
	Digit 7	X	0	0	0	1	0	0	0		N/A
Control Register	Decode-Mode	X	0	0	0	1	0	0	1	(see Table 10 on page 10)	10
	Global Intensity	X	0	0	0	1	0	1	0	(see Table 17 on page 13)	13
	Scan Limit	X	0	0	0	1	0	1	1	(see Table 19 on page 13)	13
	Shutdown	X	0	0	0	1	1	0	0	(see Table 9 on page 10)	9
	Not Used	X	0	0	0	1	1	0	1		N/A
	Feature	X	0/1	0	0	1	1	1	0	(see Table 20 on page 14)	14
	Display Test Mode	X	0	0	0	1	1	1	1	(see Table 14 on page 12)	10
	DIG0:DIG1 Intensity	X	0	0	1	0	0	0	0	(see Table 18 on page 13)	
	DIG2:DIG3 Intensity	X	0	0	1	0	0	0	1	(see Table 18 on page 13)	
	DIG4:DIG5 Intensity	X	0	0	1	0	0	1	0	(see Table 18 on page 13)	
DIG6:DIG7 Intensity	X	0	0	1	0	0	1	1	(see Table 18 on page 13)		

Table 8. Register Address Map

Type	Register	Address								Page	
		D15	D14	D13	D12	D11	D10	D9	D8		D7:D0
Diagnostic Register	Diagnostic Digit 0	X	1	0	1	0	1	0	0		N/A
	Diagnostic Digit 1	X	1	0	1	0	1	0	1		N/A
	Diagnostic Digit 2	X	1	0	1	0	1	1	0		N/A
	Diagnostic Digit 3	X	1	0	1	0	1	1	1		N/A
	Diagnostic Digit 4	X	1	0	1	1	0	0	0		N/A
	Diagnostic Digit 5	X	1	0	1	1	0	0	1		N/A
	Diagnostic Digit 6	X	1	0	1	1	0	1	0		N/A
	Diagnostic Digit 7	X	1	0	1	1	0	1	1		N/A

Note: Write operation: D14=0; Read operation: D14=1.

The Shutdown Register controls AS1118 shutdown mode.

Table 9. Shutdown Register Format (Address (HEX) = 0x0C)

Mode	HEX Code	Register Data							
		D7	D6	D5	D4	D3	D2	D1	D0
Shutdown Mode, Reset Feature Register to Default Settings	0x00	0	X	X	X	X	X	X	0
Shutdown Mode, Feature Register Unchanged	0x80	1	X	X	X	X	X	X	0
Normal Operation, Reset Feature Register to Default Settings	0x01	0	X	X	X	X	X	X	1
Normal Operation, Feature Register Unchanged	0x81	1	X	X	X	X	X	X	1

Decode Enable Register (0x09)

The Decode Enable Register sets the decode mode. BCD/HEX decoding (either BCD code – characters 0:9, E, H, L, P, and -, or HEX code – characters 0:9 and A:F) is selected by bit D2 (page 14) of the Feature Register. The Decode Enable Register is used to select the decode mode or no-decode for each digit. Each bit in the Decode Enable Register corresponds to its respective display digit (i.e., bit D0 corresponds to digit 0, bit D1 corresponds to digit 1 and so on). Table 11 lists some examples of the possible settings for the Decode Enable Register bits.

Note: A logic high enables decoding and a logic low bypasses the decoder altogether.

















When decode mode is used, the decoder looks only at the lower-nibble (bits D3:D0) of the data in the Digit-Registers, disregarding bits D6:D4. Bit D7 sets the decimal point (SEG DP) independent of the decoder and is positive logic (bit D7 = 1 turns the decimal point on). Table 11 lists the code-B font; Table 12 lists the HEX font.

When no-decode mode is selected, data bits D7:D0 of the Digit-Registers correspond to the segment lines of the AS1118. Table 13 shows the 1:1 pairing of each data bit to the appropriate segment line.

Table 10. Decode Enable Register Format Examples

















Decode Mode	HEX Code	Register Data							
		D7	D6	D5	D4	D3	D2	D1	D0
No decode for digits 7:0	0x00	0	0	0	0	0	0	0	0
Code-B/HEX decode for digit 0. No decode for digits 7:1	0x01	0	0	0	0	0	0	0	1
Code-B/HEX decode for digit 0:2. No decode for digits 7:3	0x07	0	0	0	0	0	1	1	1
Code-B/HEX decode for digits 0:5. No decode for digits 7:6	0x3F	0	0	1	1	1	1	1	1
Code-B/HEX decode for digits 0,2,5. No decode for digits 1, 3, 4, 6, 7	0x25	0	0	1	0	0	1	0	1

Table 11. Code-B Font

Char-acter	Register Data						Char-acter	Register Data						Char-acter	Register Data					
	D7	D6:D4	D3	D2	D1	D0		D7	D6:D4	D3	D2	D1	D0		D7	D6:D4	D3	D2	D1	D0
		X	0	0	0	0			X	0	1	1	0			X	1	1	0	0
		X	0	0	0	1			X	0	1	1	1			X	1	1	0	1
		X	0	0	1	0			X	1	0	0	0			X	1	1	1	0
		X	0	0	1	1			X	1	0	0	1			X	1	1	1	1
		X	0	1	0	0			X	1	0	1	0		1*	X	X	X	X	X
		X	0	1	0	1			X	1	0	1	1							

* The decimal point can be enabled with every character by setting bit D7 = 1.

Table 12. HEX Font

Char-acter	Register Data						Char-acter	Register Data						Char-acter	Register Data					
	D7	D6:D4	D3	D2	D1	D0		D7	D6:D4	D3	D2	D1	D0		D7	D6:D4	D3	D2	D1	D0
		X	0	0	0	0			X	0	1	1	0			X	1	1	0	0
		X	0	0	0	1			X	0	1	1	1			X	1	1	0	1
		X	0	0	1	0			X	1	0	0	0			X	1	1	1	0
		X	0	0	1	1			X	1	0	0	1			X	1	1	1	1
		X	0	1	0	0			X	1	0	1	0		1*	X	X	X	X	X
		X	0	1	0	1			X	1	0	1	1							

* The decimal point can be enabled with every character by setting bit D7 = 1.

Table 13. No-Decode Mode Data Bits and Corresponding Segment Lines

	D7	D6	D5	D4	D3	D2	D1	D0
Corresponding Segment Line	DP	A	B	C	D	E	F	G

Figure 19. Standard 7-Segment LED

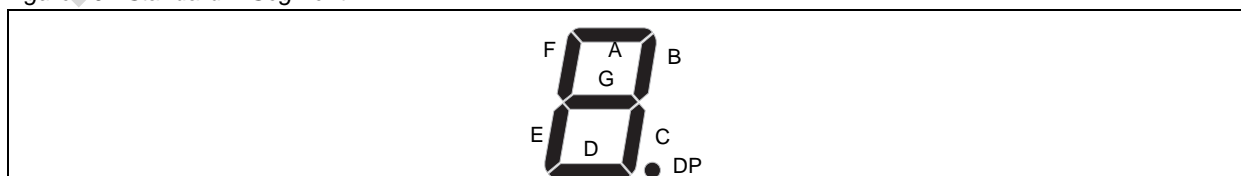

Display-Test Mode

The AS1118 can detect open or shorted LEDs. Readout of either open LEDs (D2=1) or short LEDs (D1=1) is possible, as well as a OR relation of open and short (D1=D2=1). After a diagnostic run bit D4 can be read to clarify if an error occurred before reading out detailed diagnostic data.

Note: All settings of the digit- and control-registers are maintained.

Table 14. Testmode Register Summary

D7	D6	D5	D4	D3	D2	D1	D0
X	REXT_short	REXT_open	LED_global	LED_test	LED_open	LED_short	DISP_test

Table 15. Testmode Register Bit Description (Address (HEX) = 0x0F)

Addr: 0x0F		Address					
Bit	Bit Name	Default	Access	D7:D0			
D0	DISP_test	0	W	Optical display test. (Testmode for external visual test.) 0: Normal operation; 1: Run display test (All digits are tested independently from scan limit & shutdown register.)			
D1	LED_short	0	W	Starts a test for shorted LEDs. (Can be set together with D2) 0: Normal operation; 1: Activate testmode			
D2	LED_open	0	W	Starts a test for open LEDs. (Can be set together with D1) 0: Normal operation; 1: Activate testmode			
D3	LED_test	0	R	Indicates an ongoing open/short LED test 0: No ongoing LED test; 1: LED test in progress			
D4	LED_global	0	R	Indicates that the last open/short LED test has detected an error 0: No error detected; 1: Error detected			
D5	REXT_open	0	R	Checks if external resistor REXT is open 0: REXT correct; 1: REXT is open			
D6	REXT_short	0	R	Checks if external resistor REXT is shorted 0: REXT correct; 1: REXT is shorted			
D7		0	-	Not used			

LED Diagnostic Registers

These eight registers contain the result of the LED open/short test for the individual LED of each digit.

Table 16. LED Diagnostic Register Address

Register HEX Address	Digit	Segment								Register HEX Address	Digit	Segment							
		D7	D6	D5	D4	D3	D2	D1	D0			D7	D6	D5	D4	D3	D2	D1	D0
0x14	DIG0	DP	A	B	C	D	E	F	G	0x18	DIG4	DP	A	B	C	D	E	F	G
0x15	DIG1									0x19	DIG5								
0x16	DIG2									0x1A	DIG6								
0x17	DIG3									0x1B	DIG7								

Note: If more than 2 shorts occur in the LED array, detection of individual LED fault could become limited to blocs.

Intensity Control Register (0x0A)

The brightness of the display can be controlled by digital means using the Intensity Control Registers and by analog means using RSET (see [Selecting RSET Resistor Value and Using External Drivers on page 15](#)). The intensity can be controlled globally for all digits, or for each digit individually. The global intensity command will write intensity data to all four individual brightness registers, while the individual intensity command will only write to the associated individual intensity register.

Display brightness is controlled by an integrated pulse-width modulator which is controlled by the lower-nibble of the Intensity Control Register. The modulator scales the average segment-current in 16 steps from a maximum of 15/16 down to 1/16 of the peak current set by RSET.

Table 17. Intensity Register Format

Duty Cycle	HEX Code	Register Data				Duty Cycle	HEX Code	Register Data			
		MSB	D2	D1	LSB			MSB	D2	D1	LSB
1/16 (min on)	0xX0	0	0	0	0	9/16	0xX8	1	0	0	0
2/16	0xX1	0	0	0	1	10/16	0xX9	1	0	0	1
3/16	0xX2	0	0	1	0	11/16	0xXA	1	0	1	0
4/16	0xX3	0	0	1	1	12/16	0xXB	1	0	1	1
5/16	0xX4	0	1	0	0	13/16	0xXC	1	1	0	0
6/16	0xX5	0	1	0	1	14/16	0xDD	1	1	0	1
7/16	0xX6	0	1	1	0	15/16	0xXE	1	1	1	0
8/16	0xX7	0	1	1	1	15/16 (max on)	0xFF	1	1	1	1

Table 18. Intensity Register Address

Register HEX Address	Type	Register Data	
		D7:D4	D3:D0
0x0A	Global	X	Global Intensity
0x10	Digit	Digit 1 Intensity	Digit 0 Intensity
0x11	Digit	Digit 3 Intensity	Digit 2 Intensity
0x12	Digit	Digit 5 Intensity	Digit 4 Intensity
0x13	Digit	Digit 7 Intensity	Digit 6 Intensity

Scan-Limit Register (0x0B)

The Scan-Limit Register controls which of the digits are to be displayed. When all 8 digits are to be displayed, the update frequency is typically 0.8kHz. If the number of digits displayed is reduced, the update frequency is increased. The frequency can be calculated using $8f_{OSC}/N$, where N is the number of digits. Since the number of displayed digits influences the brightness, RSET should be adjusted accordingly.

Note: To avoid differences in brightness this register should not be used to blank parts of the display (leading zeros).

Table 19. Scan-Limit Register Format (Address (HEX) = 0x0B)

Scan Limit	HEX Code	Register Data				Scan Limit	HEX Code	Register Data			
		D7:D3	D2	D1	D0			D7:D3	D2	D1	D0
Display digit 0 only	0xX0	X	0	0	0	Display digits 0:4	0xX4	X	1	0	0
Display digits 0:1	0xX1	X	0	0	1	Display digits 0:5	0xX5	X	1	0	1
Display digits 0:2	0xX2	X	0	1	0	Display digits 0:6	0xX6	X	1	1	0
Display digits 0:3	0xX3	X	0	1	1	Display digits 0:7	0xX7	X	1	1	1

Feature Register (0x0E)

The Feature Register is used for enabling various features including switching the device into external clock mode, applying an external reset, selecting code-B or HEX decoding, enabling or disabling blinking, enabling or disabling the SPI-compatible interface, setting the blinking rate, and resetting the blink timing.

Note: At power-up the Feature Register is initialized to 0.

Table 20. Feature Register Summary

D7	D6	D5	D4	D3	D2	D1	D0
blink_start	sync	blink_freq_sel	blink_en	NU	decode_sel	reg_res	clk_en

Table 21. Feature Register Bit Descriptions (Address (HEX) = 0xXE)

Addr: 0xXE		Feature Register		Bit Description
		Enables and disables various device features.		
Bit	Bit Name	Default	Access	
D0	clk_en	0	R/W	External clock active. 0 = Internal oscillator is used for system clock. 1 = Pin CLK of the serial interface operates as system clock input.
D1	reg_res	0	R/W	Resets all control registers except the Feature Register. 0 = Reset Disabled. Normal operation. 1 = All control registers are reset to default state (except the Feature Register) identically after power-up. Note: The Digit Registers maintain their data.
D2	decode_sel	0	R/W	Selects display decoding for the selected digits (Table 10 on page 10). 0 = Enable Code-B decoding (see Table 11 on page 11). 1 = Enable HEX decoding (see Table 12 on page 11).
D3	NU			Not used
D4	blink_en	0	R/W	Enables blinking. 0 = Disable blinking. 1 = Enable blinking.
D5	blink_freq_sel	0	R/W	Sets blink with low frequency (with the internal oscillator enabled): 0 = Blink period typically is 1 second (0.5s on, 0.5s off). 1 = Blink period is 2 seconds (1s on, 1s off).
D6	sync	0	R/W	Synchronizes blinking on the rising edge of pin LD. The multiplex and blink timing counter is cleared on the rising edge of pin LD. By setting this bit in multiple devices, the blink timing can be synchronized across all the devices.
D7	blink_start	0	R/W	Start Blinking with display enabled phase. When bit D4 (blink_en) is set, bit D7 determines how blinking starts. 0 = Blinking starts with the display turned off. 1 = Blinking starts with the display turned on.

No-Op Register (0xX0)

The No-Op Register is used when multiple AS1118 devices are cascaded in order to support displays with more than 8 digits. The cascading must be done in such a way that all SDO pins are connected to SDI of the next AS1118 (see Figure 20 on page 16). The LD and SCL signals are connected to all devices.

For example, if five devices are cascaded, in order to perform a write operation to the fifth device, the write-command must be followed by four no-operation commands. When the LD signal goes high, all shift registers are latched. The first four devices will receive no-operation commands and only the fifth device will receive the intended operation command, and subsequently update its register.

9 Typical Application

Selecting R_{SET} Resistor Value and Using External Drivers

Brightness of the display segments is controlled via R_{SET}. The current that flows between V_{DD} and I_{SET} defines the current that flows through the LEDs.

Segment current is about 200 times the current in I_{SET}. Typical values for R_{SET} for different segment currents, operating voltages, and LED voltage drop (V_{LED}) are given in Table 22 & Table 23. The maximum current the AS1118 can drive is 47mA. If higher currents are needed, external drivers must be used, in which case it is no longer necessary that the devices drive high currents.

Note: The display brightness can also be logically controlled (see Intensity Control Register (0x0A) on page 12).

Table 22. R_{SET} vs. Segment Current and LED Forward Voltage, V_{DD} = 2.7V & 3.3V & 3.6V

I _{SEG} (mA)	V _{LED}		V _{LED}			V _{LED}						
	1.5V	2.0V	1.5V	2.0V	2.5V	1.5V	2.0V	2.5V	3.0V			
40	V _{DD} = 2.7V	5kΩ	V _{DD} = 3.3V	6.7kΩ	6.4kΩ	5.7kΩ	V _{DD} = 3.6V	7.5kΩ	7.2kΩ	6.6kΩ	5.5kΩ	
30		6.9kΩ		5.9kΩ	9.1kΩ	8.8kΩ		8.1kΩ	10.18kΩ	9.8kΩ	9.2kΩ	7.5kΩ
20		10.7kΩ		9.6kΩ	13.9kΩ	13.3kΩ		12.6kΩ	15.6kΩ	15kΩ	14.3kΩ	13kΩ
10		22.2kΩ		20.7kΩ	28.8kΩ	27.7kΩ		26kΩ	31.9kΩ	31kΩ	29.5kΩ	27.3kΩ

Table 23. R_{SET} vs. Segment Current and LED Forward Voltage, V_{DD} = 4.0V & 5.0V

I _{SEG} (mA)	V _{LED}					V _{LED}							
	1.5V	2.0V	2.5V	3.0V	3.5V	1.5V	2.0V	2.5V	3.0V	3.5V	4.0V		
40	V _{DD} = 4.0V	8.6kΩ	8.3kΩ	7.9kΩ	7.6kΩ	5.2kΩ	V _{DD} = 5.0V	11.35kΩ	11.12kΩ	10.84kΩ	10.49kΩ	10.2kΩ	9.9kΩ
30		11.6kΩ	11.2kΩ	10.8kΩ	9.9kΩ	7.8kΩ		15.4kΩ	15.1kΩ	14.7kΩ	14.4kΩ	13.6kΩ	13.1kΩ
20		17.7kΩ	17.3kΩ	16.6kΩ	15.6kΩ	13.6kΩ		23.6kΩ	23.1kΩ	22.6kΩ	22kΩ	21.1kΩ	20.2kΩ
10		36.89kΩ	35.7kΩ	34.5kΩ	32.5kΩ	29.1kΩ		48.9kΩ	47.8kΩ	46.9kΩ	45.4kΩ	43.8kΩ	42kΩ

Calculating Power Dissipation

The upper limit for power dissipation (PD) for the AS1118 is determined from the following equation:

$$PD = (V_{DD} \times 5mA) + (V_{DD} - V_{LED})(DUTY \times I_{SEG} \times N) \quad (EQ 1)$$

Where:

V_{DD} is the supply voltage.

DUTY is the duty cycle set by intensity register (page 13).

N is the number of segments driven (worst case is 8)

V_{LED} is the LED forward voltage

I_{SEG} = segment current set by R_{SET}

Dissipation Example:

$$I_{SEG} = 40mA, N = 8, DUTY = 15/16, V_{LED} = 2.2V \text{ at } 40mA, V_{DD} = 5V \quad (EQ 2)$$

$$PD = 5V(5mA) + (5V - 2.2V)(15/16 \times 40mA \times 8) = 0.865W \quad (EQ 3)$$

Thus, for a QSOP-24 package $\Theta_{JA} = +88^\circ\text{C/W}$, the maximum allowed T_{AMB} is given by:

$$T_{J,MAX} = T_{AMB} + PD \times \Theta_{JA} = 150^\circ\text{C} = T_{AMB} + 0.865W \times 88^\circ\text{C/W} \quad (EQ 4)$$

In this example the maximum ambient temperature must stay below 73.88°C.

8x8 Dot Matrix Mode

The application example in [Figure 20](#) shows the AS1118 in the 8x8 LED dot matrix mode.

The LED columns have common cathodes and are connected to the DIG0:7 outputs. The rows are connected to the segment drivers. Each of the 64 LEDs can be addressed separately. The columns are selected via the digits as listed in [Table 8 on page 9](#).

The Decode Enable Register ([see page 10](#)) must be set to '00000000' as described in [Table 10 on page 10](#). Single LEDs in a column can be addressed as described in [Table 13 on page 11](#), where bit D0 corresponds to segment G and bit D7 corresponds to segment DP.

Note: For a multiple-digit dot matrix, multiple AS1118 devices can be cascaded easily.

Figure 20. Application Example as LED Dot Matrix Driver

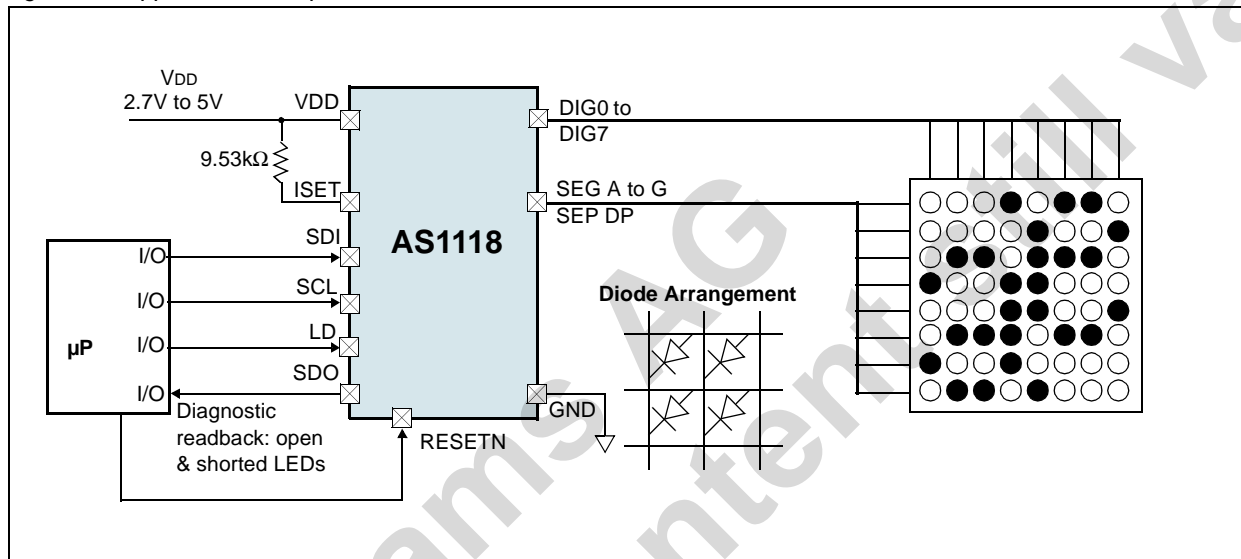

Supply Bypassing and Wiring

In order to achieve optimal performance the AS1118 should be placed very close to the LED display to minimize effects of electromagnetic interference and wiring inductance.

Furthermore, it is recommended to connect a 10µF electrolytic and a 0.1µF ceramic capacitor between pins VDD and GND to avoid power supply ripple ([see Figure 15 on page 7](#)).

10 Package Drawings and Markings

Figure 21. TQFN(4x4)-24 Marking

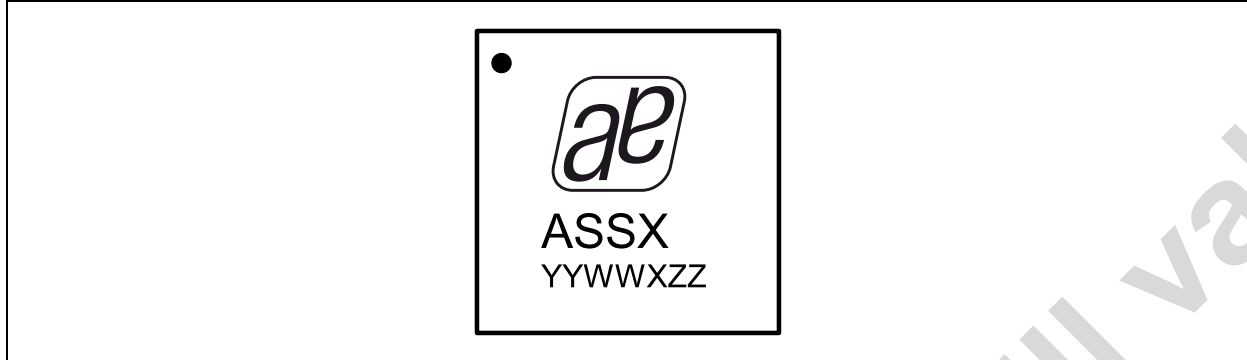
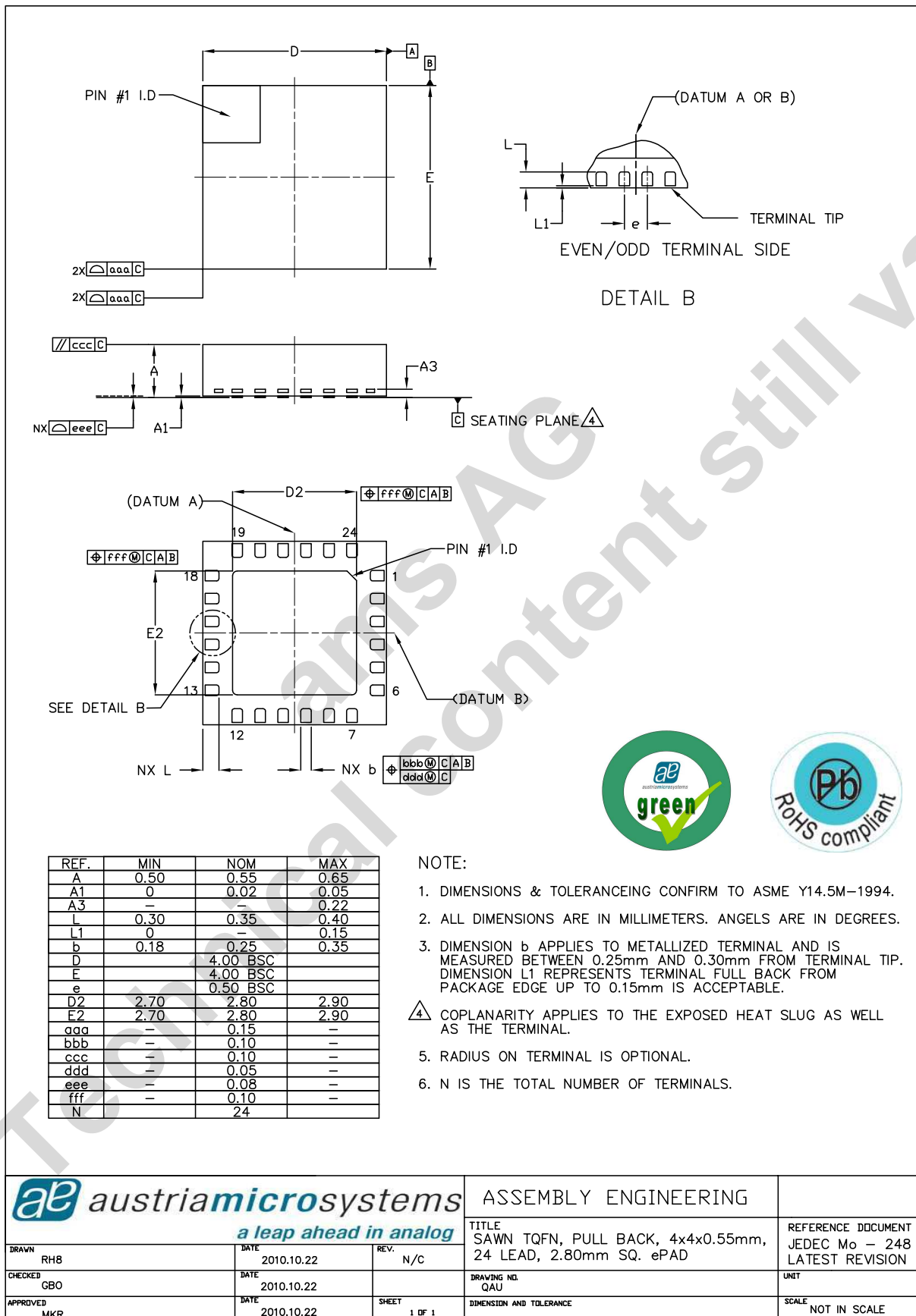

Table 24. Packaging Code YYWWIZZ

YY	WW	X	ZZ
last two digits of the current year	manufacturing week	plant identifier	free choice / traceability code

Figure 22. TQFN(4x4)-24 Package



11 Ordering Information

The devices are available as the standard products shown in [Table 25](#).

Table 25. Ordering Information

Ordering Code	Marking	Description	Delivery Form	Package
AS1118-BQFT	ASSX	64 LED Driver for Mobile Applications with Error Detection	Tape and Reel	TQFN(4x4)-24

Note: All products are RoHS compliant and austriamicrosystems green.

Buy our products or get free samples online at ICdirect: <http://www.austriamicrosystems.com/ICdirect>

Technical Support is found at <http://www.austriamicrosystems.com/Technical-Support>

For further information and requests, please contact us <mailto:sales@austriamicrosystems.com> or find your local distributor at <http://www.austriamicrosystems.com/distributor>

Copyrights

Copyright © 1997-2012, austriamicrosystems AG, Tobelbaderstrasse 30, 8141 Unterpremstaetten, Austria-Europe. Trademarks Registered ®. All rights reserved. The material herein may not be reproduced, adapted, merged, translated, stored, or used without the prior written consent of the copyright owner.

All products and companies mentioned are trademarks or registered trademarks of their respective companies.

Disclaimer

Devices sold by austriamicrosystems AG are covered by the warranty and patent indemnification provisions appearing in its Term of Sale. austriamicrosystems AG makes no warranty, express, statutory, implied, or by description regarding the information set forth herein or regarding the freedom of the described devices from patent infringement. austriamicrosystems AG reserves the right to change specifications and prices at any time and without notice. Therefore, prior to designing this product into a system, it is necessary to check with austriamicrosystems AG for current information. This product is intended for use in normal commercial applications. Applications requiring extended temperature range, unusual environmental requirements, or high reliability applications, such as military, medical life-support or life-sustaining equipment are specifically not recommended without additional processing by austriamicrosystems AG for each application. For shipments of less than 100 parts the manufacturing flow might show deviations from the standard production flow, such as test flow or test location.

The information furnished here by austriamicrosystems AG is believed to be correct and accurate. However, austriamicrosystems AG shall not be liable to recipient or any third party for any damages, including but not limited to personal injury, property damage, loss of profits, loss of use, interruption of business or indirect, special, incidental or consequential damages, of any kind, in connection with or arising out of the furnishing, performance or use of the technical data herein. No obligation or liability to recipient or any third party shall arise or flow out of austriamicrosystems AG rendering of technical or other services.



Contact Information

Headquarters

austriamicrosystems AG
Tobelbaderstrasse 30
A-8141 Unterpremstaetten, Austria

Tel: +43 (0) 3136 500 0
Fax: +43 (0) 3136 525 01

For Sales Offices, Distributors and Representatives, please visit:

<http://www.austriamicrosystems.com/contact>