

Reference Specification

Leaded MLCC for General Purpose
RDE Series

Product specifications in this catalog are as of Jun. 2022, and are subject to change or obsolescence without notice.
Please consult the approval sheet before ordering. Please read rating and Cautions first.

⚠ CAUTION**1. OPERATING VOLTAGE**

When DC-rated capacitors are to be used in AC or ripple current circuits, be sure to maintain the V_{p-p} value of the applied voltage or the V_{o-p} which contains DC bias within the rated voltage range. When the voltage is started to apply to the circuit or it is stopped applying, the irregular voltage may be generated for a transit period because of resonance or switching. Be sure to use a capacitor within rated voltage containing these irregular voltage.

When DC-rated capacitors are to be used in input circuits from commercial power source (AC filter), be sure to use Safety Recognized Capacitors because various regulations on withstand voltage or impulse withstand established for each equipment should be taken into considerations.

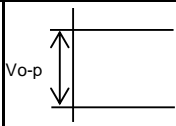
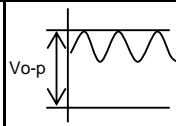
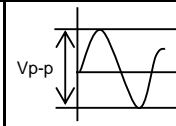
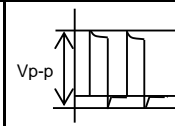
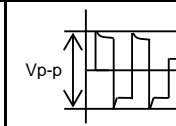
Voltage	DC Voltage	DC+AC Voltage	AC Voltage	Pulse Voltage(1)	Pulse Voltage(2)
Positional Measurement					

2. OPERATING TEMPERATURE AND SELF-GENERATED HEAT

Keep the surface temperature of a capacitor below the upper limit of its rated operating temperature range. Be sure to take into account the heat generated by the capacitor itself.

When the capacitor is used in a high-frequency current, pulse current or the like, it may have the self-generated heat due to dielectric-loss. In case of Class 2 capacitors (Temp.Char. : X7R,X7S,X8L, etc.), applied voltage should be the load such as self-generated heat is within 20 °C on the condition of atmosphere temperature 25 °C. Please contact us if self-generated heat is occurred with Class 1 capacitors (Temp.Char. : C0G,U2J,X8G, etc.). When measuring, use a thermocouple of small thermal capacity-K of $\Phi 0.1\text{mm}$ and be in the condition where capacitor is not affected by radiant heat of other components and wind of surroundings. Excessive heat may lead to deterioration of the capacitor's characteristics and reliability.

3. FAIL-SAFE

Be sure to provide an appropriate fail-safe function on your product to prevent a second damage that may be caused by the abnormal function or the failure of our product.

4. OPERATING AND STORAGE ENVIRONMENT

The insulating coating of capacitors does not form a perfect seal; therefore, do not use or store capacitors in a corrosive atmosphere, especially where chloride gas, sulfide gas, acid, alkali, salt or the like are present. And avoid exposure to moisture. Before cleaning, bonding, or molding this product, verify that these processes do not affect product quality by testing the performance of a cleaned, bonded or molded product in the intended equipment. Store the capacitors where the temperature and relative humidity do not exceed 5 to 40 °C and 20 to 70%. Use capacitors within 6 months.

5. VIBRATION AND IMPACT

Do not expose a capacitor or its leads to excessive shock or vibration during use.

6. SOLDERING

When soldering this product to a PCB/PWB, do not exceed the solder heat resistance specification of the capacitor. Subjecting this product to excessive heating could melt the internal junction solder and may result in thermal shocks that can crack the ceramic element.

7. BONDING AND RESIN MOLDING, RESIN COAT

In case of bonding, molding or coating this product, verify that these processes do not affect the quality of capacitor by testing the performance of a bonded or molded product in the intended equipment.

In case of the amount of applications, dryness / hardening conditions of adhesives and molding resins containing organic solvents (ethyl acetate, methyl ethyl ketone, toluene, etc.) are unsuitable, the outer coating resin of a capacitor is damaged by the organic solvents and it may result, worst case, in a short circuit.

The variation in thickness of adhesive or molding resin may cause a outer coating resin cracking and/or ceramic element cracking of a capacitor in a temperature cycling.

8. TREATMENT AFTER BONDING AND RESIN MOLDING, RESIN COAT

When the outer coating is hot (over 100 °C) after soldering, it becomes soft and fragile.

So please be careful not to give it mechanical stress.

Failure to follow the above cautions may result, worst case, in a short circuit and cause fuming or partial dispersion when the product is used.

9. LIMITATION OF APPLICATIONS

Please contact us before using our products for the applications listed below which require especially high reliability for the prevention of defects which might directly cause damage to the third party's life, body or property.

1. Aircraft equipment
2. Aerospace equipment
3. Undersea equipment
4. Power plant control equipment
5. Medical equipment
6. Transportation equipment (vehicles, trains, ships, etc.)
7. Traffic signal equipment
8. Disaster prevention / crime prevention equipment
9. Data-processing equipment exerting influence on public
10. Application of similar complexity and/or reliability requirements to the applications listed in the above.

NOTICE

1. CLEANING (ULTRASONIC CLEANING)

To perform ultrasonic cleaning, observe the following conditions.

Rinse bath capacity : Output of 20 watts per liter or less.

Rinsing time : 5 min maximum.

Do not vibrate the PCB/PWB directly.

Excessive ultrasonic cleaning may lead to fatigue destruction of the lead wires.

2. SOLDERING AND MOUNTING

Insertion of the Lead Wire

- When soldering, insert the lead wire into the PCB without mechanically stressing the lead wire.
- Insert the lead wire into the PCB with a distance appropriate to the lead space.

3. CAPACITANCE CHANGE OF CAPACITORS

- Class 2 capacitors (Temp.Char. : X7R,X7S,X8L etc.)

Class 2 capacitors an aging characteristic, whereby the capacitor continually decreases its capacitance slightly if the capacitor leaves for a long time. Moreover, capacitance might change greatly depending on a surrounding temperature or an applied voltage. So, it is not likely to be able to use for the time constant circuit.

Please contact us if you need a detail information.

NOTE

1. Please make sure that your product has been evaluated in view of your specifications with our product being mounted to your product.
2. You are requested not to use our product deviating from this specification.

1. Application

This product specification is applied to Leaded MLCC RDE series used for General Electronic equipment.

Do not use these products in any automotive power train or safety equipment including battery chargers for electric vehicles and plug-in hybrids.

2. Rating

• Part Number Configuration

ex.)	<u>RDE</u>	<u>R7</u>	<u>1E</u>	<u>104</u>	<u>K</u>	<u>0</u>	<u>P1</u>	<u>H03</u>	<u>B</u>
	Series	Temperature Characteristics	Rated Voltage	Capacitance	Capacitance Tolerance	Dimension (LxW)	Lead Style	Individual Specification	Package

• Temperature Characteristics

Code	Temp. Char.	Temp. Range	Cap. Change	Standard Temp.	Operating Temp. Range
R7	X7R (EIA code)	-55~125°C	+/-15%	25°C	-55~125°C
C7	X7S (EIA code)	-55~125°C	+/-22%	25°C	-55~125°C

• Rated Voltage

Code	Rated voltage
1E	DC25V
1H	DC50V
2A	DC100V

• Capacitance

The first two digits denote significant figures ; the last digit denotes the multiplier of 10 in pF.

ex.) In case of 104

$$10 \times 10^4 = 100000 \text{ pF}$$

• Capacitance Tolerance

Code	Capacitance Tolerance
K	+/-10%
M	+/-20%

• Dimension (LxW)

Please refer to [Part number list].

• Lead Style

*Lead wire is "solder coated CP wire".

Code	Lead Style	Lead spacing (mm)
K1	Inside crimp type	5.0+/-0.8
M1	Inside crimp taping type	5.0+0.6/-0.2
P1	Outside crimp type	2.5+/-0.8
S1	Outside crimp taping type	2.5+0.4/-0.2

• Individual Specification

Murata's control code.

Please refer to [Part number list].

4. Part number list

- Outside Crimp
(Lead Style : P1)

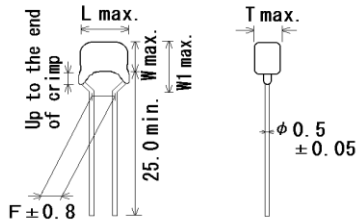

Unit : mm

Customer Part Number	Murata Part Number	T.C.	DC Rated Volt. (V)	Cap.	Cap. Tol.	Dimension (mm)					Dimension (LxW) Lead Style	Pack qty. (pcs)
						L	W	W1	F	T		
	RDER71E104K0P1H03B	X7R	25	0.10μF	±10%	5.0	3.5	6.0	2.5	2.5	0P1	500
	RDEC71E224K0P1H03B	X7S	25	0.22μF	±10%	5.0	3.5	6.0	2.5	2.5	0P1	500
	RDEC71E474K0P1H03B	X7S	25	0.47μF	±10%	5.0	3.5	6.0	2.5	2.5	0P1	500
	RDEC71E105K0P1H03B	X7S	25	1.0μF	±10%	5.0	3.5	6.0	2.5	2.5	0P1	500
	RDEC71E225K1P1H03B	X7S	25	2.2μF	±10%	5.0	3.5	5.0	2.5	3.15	1P1	500
	RDEC71E475K2P1H03B	X7S	25	4.7μF	±10%	5.5	4.0	6.0	2.5	3.15	2P1	500
	RDEC71E106K2P1H03B	X7S	25	10μF	±10%	5.5	4.0	6.0	2.5	3.15	2P1	500
	RDEC71E226K3P1H03B	X7S	25	22μF	±10%	5.5	5.0	7.5	2.5	4.0	3P1	500
	RDER71H221K0P1H03B	X7R	50	220pF	±10%	5.0	3.5	6.0	2.5	2.5	0P1	500
	RDER71H331K0P1H03B	X7R	50	330pF	±10%	5.0	3.5	6.0	2.5	2.5	0P1	500
	RDER71H471K0P1H03B	X7R	50	470pF	±10%	5.0	3.5	6.0	2.5	2.5	0P1	500
	RDER71H681K0P1H03B	X7R	50	680pF	±10%	5.0	3.5	6.0	2.5	2.5	0P1	500
	RDER71H102K0P1H03B	X7R	50	1000pF	±10%	5.0	3.5	6.0	2.5	2.5	0P1	500
	RDER71H152K0P1H03B	X7R	50	1500pF	±10%	5.0	3.5	6.0	2.5	2.5	0P1	500
	RDER71H222K0P1H03B	X7R	50	2200pF	±10%	5.0	3.5	6.0	2.5	2.5	0P1	500
	RDER71H332K0P1H03B	X7R	50	3300pF	±10%	5.0	3.5	6.0	2.5	2.5	0P1	500
	RDER71H472K0P1H03B	X7R	50	4700pF	±10%	5.0	3.5	6.0	2.5	2.5	0P1	500
	RDER71H682K0P1H03B	X7R	50	6800pF	±10%	5.0	3.5	6.0	2.5	2.5	0P1	500
	RDER71H103K0P1H03B	X7R	50	10000pF	±10%	5.0	3.5	6.0	2.5	2.5	0P1	500
	RDER71H153K0P1H03B	X7R	50	15000pF	±10%	5.0	3.5	6.0	2.5	2.5	0P1	500
	RDER71H223K0P1H03B	X7R	50	22000pF	±10%	5.0	3.5	6.0	2.5	2.5	0P1	500
	RDER71H333K0P1H03B	X7R	50	33000pF	±10%	5.0	3.5	6.0	2.5	2.5	0P1	500
	RDER71H473K0P1H03B	X7R	50	47000pF	±10%	5.0	3.5	6.0	2.5	2.5	0P1	500
	RDER71H683K0P1H03B	X7R	50	68000pF	±10%	5.0	3.5	6.0	2.5	2.5	0P1	500
	RDER71H104K0P1H03B	X7R	50	0.10μF	±10%	5.0	3.5	6.0	2.5	2.5	0P1	500
	RDER71H154K1P1H03B	X7R	50	0.15μF	±10%	5.0	3.5	5.0	2.5	3.15	1P1	500
	RDER71H224K1P1H03B	X7R	50	0.22μF	±10%	5.0	3.5	5.0	2.5	3.15	1P1	500
	RDER71H334K1P1H03B	X7R	50	0.33μF	±10%	5.0	3.5	5.0	2.5	3.15	1P1	500
	RDER71H474K1P1H03B	X7R	50	0.47μF	±10%	5.0	3.5	5.0	2.5	3.15	1P1	500
	RDER71H684K2P1H03B	X7R	50	0.68μF	±10%	5.5	4.0	6.0	2.5	3.15	2P1	500
	RDEC71H105K1P1H03B	X7S	50	1.0μF	±10%	5.0	3.5	5.0	2.5	3.15	1P1	500
	RDER71H105K2P1H03B	X7R	50	1.0μF	±10%	5.5	4.0	6.0	2.5	3.15	2P1	500
	RDER71H155K2P1H03B	X7R	50	1.5μF	±10%	5.5	4.0	6.0	2.5	3.15	2P1	500
	RDER71H225K2P1H03B	X7R	50	2.2μF	±10%	5.5	4.0	6.0	2.5	3.15	2P1	500
	RDER71H335K3P1H03B	X7R	50	3.3μF	±10%	5.5	5.0	7.5	2.5	4.0	3P1	500
	RDEC71H475K2P1H03B	X7S	50	4.7μF	±10%	5.5	4.0	6.0	2.5	3.15	2P1	500
	RDEC71H106K3P1H03B	X7S	50	10μF	±10%	5.5	5.0	7.5	2.5	4.0	3P1	500
	RDER72A221K0P1H03B	X7R	100	220pF	±10%	5.0	3.5	6.0	2.5	2.5	0P1	500
	RDER72A331K0P1H03B	X7R	100	330pF	±10%	5.0	3.5	6.0	2.5	2.5	0P1	500
	RDER72A471K0P1H03B	X7R	100	470pF	±10%	5.0	3.5	6.0	2.5	2.5	0P1	500

- Outside Crimp
(Lead Style : P1)

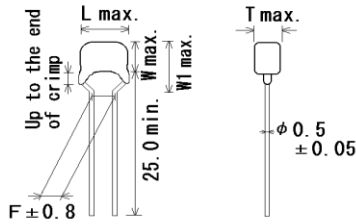

- Inside Crimp
(Lead Style : K*)

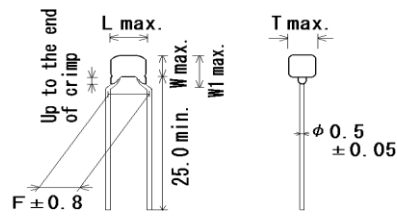

Unit : mm

Customer Part Number	Murata Part Number	T.C.	DC Rated Volt. (V)	Cap.	Cap. Tol.	Dimension (mm)					Dimension (LxW) Lead Style	Pack qty. (pcs)
						L	W	W1	F	T		
	RDER72A681K0P1H03B	X7R	100	680pF	±10%	5.0	3.5	6.0	2.5	2.5	0P1	500
	RDER72A102K0P1H03B	X7R	100	1000pF	±10%	5.0	3.5	6.0	2.5	2.5	0P1	500
	RDER72A152K0P1H03B	X7R	100	1500pF	±10%	5.0	3.5	6.0	2.5	2.5	0P1	500
	RDER72A222K0P1H03B	X7R	100	2200pF	±10%	5.0	3.5	6.0	2.5	2.5	0P1	500
	RDER72A332K0P1H03B	X7R	100	3300pF	±10%	5.0	3.5	6.0	2.5	2.5	0P1	500
	RDER72A472K0P1H03B	X7R	100	4700pF	±10%	5.0	3.5	6.0	2.5	2.5	0P1	500
	RDER72A682K0P1H03B	X7R	100	6800pF	±10%	5.0	3.5	6.0	2.5	2.5	0P1	500
	RDER72A103K0P1H03B	X7R	100	10000pF	±10%	5.0	3.5	6.0	2.5	2.5	0P1	500
	RDER72A153K0P1H03B	X7R	100	15000pF	±10%	5.0	3.5	6.0	2.5	2.5	0P1	500
	RDER72A223K0P1H03B	X7R	100	22000pF	±10%	5.0	3.5	6.0	2.5	2.5	0P1	500
	RDER72A333K1P1H03B	X7R	100	33000pF	±10%	5.0	3.5	5.0	2.5	3.15	1P1	500
	RDER72A473K1P1H03B	X7R	100	47000pF	±10%	5.0	3.5	5.0	2.5	3.15	1P1	500
	RDER72A683K1P1H03B	X7R	100	68000pF	±10%	5.0	3.5	5.0	2.5	3.15	1P1	500
	RDER72A104K1P1H03B	X7R	100	0.10μF	±10%	5.0	3.5	5.0	2.5	3.15	1P1	500
	RDER72A154K2P1H03B	X7R	100	0.15μF	±10%	5.5	4.0	6.0	2.5	3.15	2P1	500
	RDER72A224K1P1H03B	X7R	100	0.22μF	±10%	5.0	3.5	5.0	2.5	3.15	1P1	500
	RDER72A334K1P1H03B	X7R	100	0.33μF	±10%	5.0	3.5	5.0	2.5	3.15	1P1	500
	RDER72A474K1P1H03B	X7R	100	0.47μF	±10%	5.0	3.5	5.0	2.5	3.15	1P1	500
	RDER72A684K2P1H03B	X7R	100	0.68μF	±10%	5.5	4.0	6.0	2.5	3.15	2P1	500
	RDER72A105K2P1H03B	X7R	100	1.0μF	±10%	5.5	4.0	6.0	2.5	3.15	2P1	500
	RDEC72A155K3P1H03B	X7S	100	1.5μF	±10%	5.5	5.0	7.5	2.5	4.0	3P1	500
	RDEC72A225K3P1H03B	X7S	100	2.2μF	±10%	5.5	5.0	7.5	2.5	4.0	3P1	500
	RDER71E104K0K1H03B	X7R	25	0.10μF	±10%	4.0	3.5	6.0	5.0	2.5	0K1	500
	RDEC71E224K0K1H03B	X7S	25	0.22μF	±10%	4.0	3.5	6.0	5.0	2.5	0K1	500
	RDEC71E474K0K1H03B	X7S	25	0.47μF	±10%	4.0	3.5	6.0	5.0	2.5	0K1	500
	RDEC71E105K0K1H03B	X7S	25	1.0μF	±10%	4.0	3.5	6.0	5.0	2.5	0K1	500
	RDEC71E225K1K1H03B	X7S	25	2.2μF	±10%	4.5	3.5	5.0	5.0	3.15	1K1	500
	RDEC71E475K2K1H03B	X7S	25	4.7μF	±10%	5.5	4.0	6.0	5.0	3.15	2K1	500
	RDEC71E106K2K1H03B	X7S	25	10μF	±10%	5.5	4.0	6.0	5.0	3.15	2K1	500
	RDEC71E226K3K1H03B	X7S	25	22μF	±10%	5.5	5.0	7.5	5.0	4.0	3K1	500
	RDEC71E476MWWK1H03B	X7S	25	47μF	±20%	5.5	7.5	10.0	5.0	4.0	WK1	500
	RDER71H221K0K1H03B	X7R	50	220pF	±10%	4.0	3.5	6.0	5.0	2.5	0K1	500
	RDER71H331K0K1H03B	X7R	50	330pF	±10%	4.0	3.5	6.0	5.0	2.5	0K1	500
	RDER71H471K0K1H03B	X7R	50	470pF	±10%	4.0	3.5	6.0	5.0	2.5	0K1	500
	RDER71H681K0K1H03B	X7R	50	680pF	±10%	4.0	3.5	6.0	5.0	2.5	0K1	500
	RDER71H102K0K1H03B	X7R	50	1000pF	±10%	4.0	3.5	6.0	5.0	2.5	0K1	500
	RDER71H152K0K1H03B	X7R	50	1500pF	±10%	4.0	3.5	6.0	5.0	2.5	0K1	500
	RDER71H222K0K1H03B	X7R	50	2200pF	±10%	4.0	3.5	6.0	5.0	2.5	0K1	500
	RDER71H332K0K1H03B	X7R	50	3300pF	±10%	4.0	3.5	6.0	5.0	2.5	0K1	500
	RDER71H472K0K1H03B	X7R	50	4700pF	±10%	4.0	3.5	6.0	5.0	2.5	0K1	500

- Inside Crimp
(Lead Style : K*)

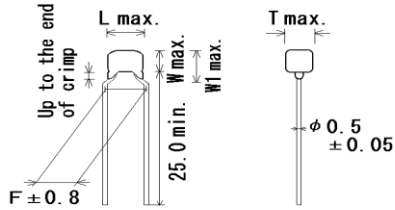

Unit : mm

Customer Part Number	Murata Part Number	T.C.	DC Rated Volt. (V)	Cap.	Cap. Tol.	Dimension (mm)					Dimension (LxW) Lead Style	Pack qty. (pcs)
						L	W	W1	F	T		
	RDER71H682K0K1H03B	X7R	50	6800pF	±10%	4.0	3.5	6.0	5.0	2.5	0K1	500
	RDER71H103K0K1H03B	X7R	50	10000pF	±10%	4.0	3.5	6.0	5.0	2.5	0K1	500
	RDER71H153K0K1H03B	X7R	50	15000pF	±10%	4.0	3.5	6.0	5.0	2.5	0K1	500
	RDER71H223K0K1H03B	X7R	50	22000pF	±10%	4.0	3.5	6.0	5.0	2.5	0K1	500
	RDER71H333K0K1H03B	X7R	50	33000pF	±10%	4.0	3.5	6.0	5.0	2.5	0K1	500
	RDER71H473K0K1H03B	X7R	50	47000pF	±10%	4.0	3.5	6.0	5.0	2.5	0K1	500
	RDER71H683K0K1H03B	X7R	50	68000pF	±10%	4.0	3.5	6.0	5.0	2.5	0K1	500
	RDER71H104K0K1H03B	X7R	50	0.10μF	±10%	4.0	3.5	6.0	5.0	2.5	0K1	500
	RDER71H154K1K1H03B	X7R	50	0.15μF	±10%	4.5	3.5	5.0	5.0	3.15	1K1	500
	RDER71H224K1K1H03B	X7R	50	0.22μF	±10%	4.5	3.5	5.0	5.0	3.15	1K1	500
	RDER71H334K1K1H03B	X7R	50	0.33μF	±10%	4.5	3.5	5.0	5.0	3.15	1K1	500
	RDER71H474K1K1H03B	X7R	50	0.47μF	±10%	4.5	3.5	5.0	5.0	3.15	1K1	500
	RDER71H684K2K1H03B	X7R	50	0.68μF	±10%	5.5	4.0	6.0	5.0	3.15	2K1	500
	RDEC71H105K1K1H03B	X7S	50	1.0μF	±10%	4.5	3.5	5.0	5.0	3.15	1K1	500
	RDER71H105K2K1H03B	X7R	50	1.0μF	±10%	5.5	4.0	6.0	5.0	3.15	2K1	500
	RDER71H155K2K1H03B	X7R	50	1.5μF	±10%	5.5	4.0	6.0	5.0	3.15	2K1	500
	RDER71H225K2K1H03B	X7R	50	2.2μF	±10%	5.5	4.0	6.0	5.0	3.15	2K1	500
	RDER71H335K3K1H03B	X7R	50	3.3μF	±10%	5.5	5.0	7.5	5.0	4.0	3K1	500
	RDEC71H475K2K1H03B	X7S	50	4.7μF	±10%	5.5	4.0	6.0	5.0	3.15	2K1	500
	RDEC71H106K3K1H03B	X7S	50	10μF	±10%	5.5	5.0	7.5	5.0	4.0	3K1	500
	RDEC71H226MWWK1H03B	X7S	50	22μF	±20%	5.5	7.5	10.0	5.0	4.0	WK1	500
	RDER72A221K0K1H03B	X7R	100	220pF	±10%	4.0	3.5	6.0	5.0	2.5	0K1	500
	RDER72A331K0K1H03B	X7R	100	330pF	±10%	4.0	3.5	6.0	5.0	2.5	0K1	500
	RDER72A471K0K1H03B	X7R	100	470pF	±10%	4.0	3.5	6.0	5.0	2.5	0K1	500
	RDER72A681K0K1H03B	X7R	100	680pF	±10%	4.0	3.5	6.0	5.0	2.5	0K1	500
	RDER72A102K0K1H03B	X7R	100	1000pF	±10%	4.0	3.5	6.0	5.0	2.5	0K1	500
	RDER72A152K0K1H03B	X7R	100	1500pF	±10%	4.0	3.5	6.0	5.0	2.5	0K1	500
	RDER72A222K0K1H03B	X7R	100	2200pF	±10%	4.0	3.5	6.0	5.0	2.5	0K1	500
	RDER72A332K0K1H03B	X7R	100	3300pF	±10%	4.0	3.5	6.0	5.0	2.5	0K1	500
	RDER72A472K0K1H03B	X7R	100	4700pF	±10%	4.0	3.5	6.0	5.0	2.5	0K1	500
	RDER72A682K0K1H03B	X7R	100	6800pF	±10%	4.0	3.5	6.0	5.0	2.5	0K1	500
	RDER72A103K0K1H03B	X7R	100	10000pF	±10%	4.0	3.5	6.0	5.0	2.5	0K1	500
	RDER72A153K0K1H03B	X7R	100	15000pF	±10%	4.0	3.5	6.0	5.0	2.5	0K1	500
	RDER72A223K0K1H03B	X7R	100	22000pF	±10%	4.0	3.5	6.0	5.0	2.5	0K1	500
	RDER72A333K1K1H03B	X7R	100	33000pF	±10%	4.5	3.5	5.0	5.0	3.15	1K1	500
	RDER72A473K1K1H03B	X7R	100	47000pF	±10%	4.5	3.5	5.0	5.0	3.15	1K1	500
	RDER72A683K1K1H03B	X7R	100	68000pF	±10%	4.5	3.5	5.0	5.0	3.15	1K1	500
	RDER72A104K1K1H03B	X7R	100	0.10μF	±10%	4.5	3.5	5.0	5.0	3.15	1K1	500
	RDER72A154K2K1H03B	X7R	100	0.15μF	±10%	5.5	4.0	6.0	5.0	3.15	2K1	500
	RDER72A224K1K1H03B	X7R	100	0.22μF	±10%	4.5	3.5	5.0	5.0	3.15	1K1	500

- Inside Crimp
(Lead Style:K*)

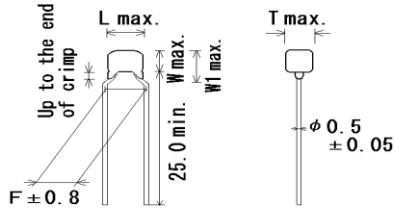

Unit : mm

Customer Part Number	Murata Part Number	T.C.	DC Rated Volt. (V)	Cap.	Cap. Tol.	Dimension (mm)					Dimension (LxW) Lead Style	Pack qty. (pcs)
						L	W	W1	F	T		
	RDER72A334K1K1H03B	X7R	100	0.33 μ F	±10%	4.5	3.5	5.0	5.0	3.15	1K1	500
	RDER72A474K1K1H03B	X7R	100	0.47 μ F	±10%	4.5	3.5	5.0	5.0	3.15	1K1	500
	RDER72A684K2K1H03B	X7R	100	0.68 μ F	±10%	5.5	4.0	6.0	5.0	3.15	2K1	500
	RDER72A105K2K1H03B	X7R	100	1.0 μ F	±10%	5.5	4.0	6.0	5.0	3.15	2K1	500
	RDEC72A155K3K1H03B	X7S	100	1.5 μ F	±10%	5.5	5.0	7.5	5.0	4.0	3K1	500
	RDEC72A225K3K1H03B	X7S	100	2.2 μ F	±10%	5.5	5.0	7.5	5.0	4.0	3K1	500
	RDEC72A475MVK1H03B	X7S	100	4.7 μ F	±20%	5.5	7.5	10.0	5.0	4.0	WK1	500

• Outside Crimp Taping
(Lead Style:S*)

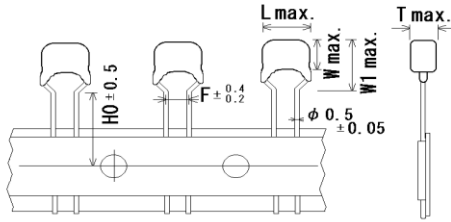

Unit : mm

Customer Part Number	Murata Part Number	T.C.	DC Rated Volt. (V)	Cap.	Cap. Tol.	Dimension (mm)						Dimension (LxW) Lead Style	Pack qty. (pcs)
						L	W	W1	F	T	H/H0		
	RDER71E104K0S1H03A	X7R	25	0.10μF	±10%	5.0	3.5	6.0	2.5	2.5	16.0	0S1	2000
	RDEC71E224K0S1H03A	X7S	25	0.22μF	±10%	5.0	3.5	6.0	2.5	2.5	16.0	0S1	2000
	RDEC71E474K0S1H03A	X7S	25	0.47μF	±10%	5.0	3.5	6.0	2.5	2.5	16.0	0S1	2000
	RDEC71E105K0S1H03A	X7S	25	1.0μF	±10%	5.0	3.5	6.0	2.5	2.5	16.0	0S1	2000
	RDEC71E225K1S1H03A	X7S	25	2.2μF	±10%	5.0	3.5	5.0	2.5	3.15	16.0	1S1	2000
	RDEC71E475K2S1H03A	X7S	25	4.7μF	±10%	5.5	4.0	6.0	2.5	3.15	16.0	2S1	2000
	RDEC71E106K2S1H03A	X7S	25	10μF	±10%	5.5	4.0	6.0	2.5	3.15	16.0	2S1	2000
	RDEC71E226K3S1H03A	X7S	25	22μF	±10%	5.5	5.0	7.5	2.5	4.0	16.0	3S1	1500
	RDER71H221K0S1H03A	X7R	50	220pF	±10%	5.0	3.5	6.0	2.5	2.5	16.0	0S1	2000
	RDER71H331K0S1H03A	X7R	50	330pF	±10%	5.0	3.5	6.0	2.5	2.5	16.0	0S1	2000
	RDER71H471K0S1H03A	X7R	50	470pF	±10%	5.0	3.5	6.0	2.5	2.5	16.0	0S1	2000
	RDER71H681K0S1H03A	X7R	50	680pF	±10%	5.0	3.5	6.0	2.5	2.5	16.0	0S1	2000
	RDER71H102K0S1H03A	X7R	50	1000pF	±10%	5.0	3.5	6.0	2.5	2.5	16.0	0S1	2000
	RDER71H152K0S1H03A	X7R	50	1500pF	±10%	5.0	3.5	6.0	2.5	2.5	16.0	0S1	2000
	RDER71H222K0S1H03A	X7R	50	2200pF	±10%	5.0	3.5	6.0	2.5	2.5	16.0	0S1	2000
	RDER71H332K0S1H03A	X7R	50	3300pF	±10%	5.0	3.5	6.0	2.5	2.5	16.0	0S1	2000
	RDER71H472K0S1H03A	X7R	50	4700pF	±10%	5.0	3.5	6.0	2.5	2.5	16.0	0S1	2000
	RDER71H682K0S1H03A	X7R	50	6800pF	±10%	5.0	3.5	6.0	2.5	2.5	16.0	0S1	2000
	RDER71H103K0S1H03A	X7R	50	10000pF	±10%	5.0	3.5	6.0	2.5	2.5	16.0	0S1	2000
	RDER71H153K0S1H03A	X7R	50	15000pF	±10%	5.0	3.5	6.0	2.5	2.5	16.0	0S1	2000
	RDER71H223K0S1H03A	X7R	50	22000pF	±10%	5.0	3.5	6.0	2.5	2.5	16.0	0S1	2000
	RDER71H333K0S1H03A	X7R	50	33000pF	±10%	5.0	3.5	6.0	2.5	2.5	16.0	0S1	2000
	RDER71H473K0S1H03A	X7R	50	47000pF	±10%	5.0	3.5	6.0	2.5	2.5	16.0	0S1	2000
	RDER71H683K0S1H03A	X7R	50	68000pF	±10%	5.0	3.5	6.0	2.5	2.5	16.0	0S1	2000
	RDER71H104K0S1H03A	X7R	50	0.10μF	±10%	5.0	3.5	6.0	2.5	2.5	16.0	0S1	2000
	RDER71H154K1S1H03A	X7R	50	0.15μF	±10%	5.0	3.5	5.0	2.5	3.15	16.0	1S1	2000
	RDER71H224K1S1H03A	X7R	50	0.22μF	±10%	5.0	3.5	5.0	2.5	3.15	16.0	1S1	2000
	RDER71H334K1S1H03A	X7R	50	0.33μF	±10%	5.0	3.5	5.0	2.5	3.15	16.0	1S1	2000
	RDER71H474K1S1H03A	X7R	50	0.47μF	±10%	5.0	3.5	5.0	2.5	3.15	16.0	1S1	2000
	RDER71H684K2S1H03A	X7R	50	0.68μF	±10%	5.5	4.0	6.0	2.5	3.15	16.0	2S1	2000
	RDEC71H105K1S1H03A	X7S	50	1.0μF	±10%	5.0	3.5	5.0	2.5	3.15	16.0	1S1	2000
	RDER71H105K2S1H03A	X7R	50	1.0μF	±10%	5.5	4.0	6.0	2.5	3.15	16.0	2S1	2000
	RDER71H155K2S1H03A	X7R	50	1.5μF	±10%	5.5	4.0	6.0	2.5	3.15	16.0	2S1	2000
	RDER71H225K2S1H03A	X7R	50	2.2μF	±10%	5.5	4.0	6.0	2.5	3.15	16.0	2S1	2000
	RDER71H335K3S1H03A	X7R	50	3.3μF	±10%	5.5	5.0	7.5	2.5	4.0	16.0	3S1	1500
	RDEC71H475K2S1H03A	X7S	50	4.7μF	±10%	5.5	4.0	6.0	2.5	3.15	16.0	2S1	2000
	RDEC71H106K3S1H03A	X7S	50	10μF	±10%	5.5	5.0	7.5	2.5	4.0	16.0	3S1	1500
	RDER72A221K0S1H03A	X7R	100	220pF	±10%	5.0	3.5	6.0	2.5	2.5	16.0	0S1	2000
	RDER72A331K0S1H03A	X7R	100	330pF	±10%	5.0	3.5	6.0	2.5	2.5	16.0	0S1	2000
	RDER72A471K0S1H03A	X7R	100	470pF	±10%	5.0	3.5	6.0	2.5	2.5	16.0	0S1	2000

• Outside Crimp Taping
(Lead Style: S*)

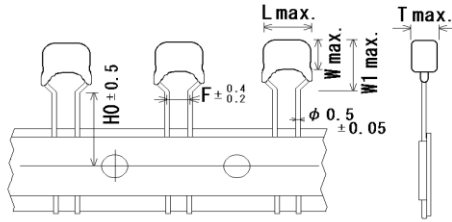

• Inside Crimp Taping
(Lead Style: M*)

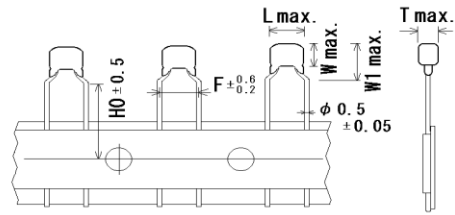

Unit : mm

Customer Part Number	Murata Part Number	T.C.	DC Rated Volt. (V)	Cap.	Cap. Tol.	Dimension (mm)						Dimension (LxW) Lead Style	Pack qty. (pcs)
						L	W	W1	F	T	H/HO		
	RDER72A681K0S1H03A	X7R	100	680pF	±10%	5.0	3.5	6.0	2.5	2.5	16.0	0S1	2000
	RDER72A102K0S1H03A	X7R	100	1000pF	±10%	5.0	3.5	6.0	2.5	2.5	16.0	0S1	2000
	RDER72A152K0S1H03A	X7R	100	1500pF	±10%	5.0	3.5	6.0	2.5	2.5	16.0	0S1	2000
	RDER72A222K0S1H03A	X7R	100	2200pF	±10%	5.0	3.5	6.0	2.5	2.5	16.0	0S1	2000
	RDER72A332K0S1H03A	X7R	100	3300pF	±10%	5.0	3.5	6.0	2.5	2.5	16.0	0S1	2000
	RDER72A472K0S1H03A	X7R	100	4700pF	±10%	5.0	3.5	6.0	2.5	2.5	16.0	0S1	2000
	RDER72A682K0S1H03A	X7R	100	6800pF	±10%	5.0	3.5	6.0	2.5	2.5	16.0	0S1	2000
	RDER72A103K0S1H03A	X7R	100	10000pF	±10%	5.0	3.5	6.0	2.5	2.5	16.0	0S1	2000
	RDER72A153K0S1H03A	X7R	100	15000pF	±10%	5.0	3.5	6.0	2.5	2.5	16.0	0S1	2000
	RDER72A223K0S1H03A	X7R	100	22000pF	±10%	5.0	3.5	6.0	2.5	2.5	16.0	0S1	2000
	RDER72A333K1S1H03A	X7R	100	33000pF	±10%	5.0	3.5	5.0	2.5	3.15	16.0	1S1	2000
	RDER72A473K1S1H03A	X7R	100	47000pF	±10%	5.0	3.5	5.0	2.5	3.15	16.0	1S1	2000
	RDER72A683K1S1H03A	X7R	100	68000pF	±10%	5.0	3.5	5.0	2.5	3.15	16.0	1S1	2000
	RDER72A104K1S1H03A	X7R	100	0.10μF	±10%	5.0	3.5	5.0	2.5	3.15	16.0	1S1	2000
	RDER72A154K2S1H03A	X7R	100	0.15μF	±10%	5.5	4.0	6.0	2.5	3.15	16.0	2S1	2000
	RDER72A224K1S1H03A	X7R	100	0.22μF	±10%	5.0	3.5	5.0	2.5	3.15	16.0	1S1	2000
	RDER72A334K1S1H03A	X7R	100	0.33μF	±10%	5.0	3.5	5.0	2.5	3.15	16.0	1S1	2000
	RDER72A474K1S1H03A	X7R	100	0.47μF	±10%	5.0	3.5	5.0	2.5	3.15	16.0	1S1	2000
	RDER72A684K2S1H03A	X7R	100	0.68μF	±10%	5.5	4.0	6.0	2.5	3.15	16.0	2S1	2000
	RDER72A105K2S1H03A	X7R	100	1.0μF	±10%	5.5	4.0	6.0	2.5	3.15	16.0	2S1	2000
	RDEC72A155K3S1H03A	X7S	100	1.5μF	±10%	5.5	5.0	7.5	2.5	4.0	16.0	3S1	1500
	RDEC72A225K3S1H03A	X7S	100	2.2μF	±10%	5.5	5.0	7.5	2.5	4.0	16.0	3S1	1500
	RDER71E104K0M1H03A	X7R	25	0.10μF	±10%	4.0	3.5	6.0	5.0	2.5	16.0	0M1	2000
	RDEC71E224K0M1H03A	X7S	25	0.22μF	±10%	4.0	3.5	6.0	5.0	2.5	16.0	0M1	2000
	RDEC71E474K0M1H03A	X7S	25	0.47μF	±10%	4.0	3.5	6.0	5.0	2.5	16.0	0M1	2000
	RDEC71E105K0M1H03A	X7S	25	1.0μF	±10%	4.0	3.5	6.0	5.0	2.5	16.0	0M1	2000
	RDEC71E225K1M1H03A	X7S	25	2.2μF	±10%	4.5	3.5	5.0	5.0	3.15	16.0	1M1	2000
	RDEC71E475K2M1H03A	X7S	25	4.7μF	±10%	5.5	4.0	6.0	5.0	3.15	16.0	2M1	2000
	RDEC71E106K2M1H03A	X7S	25	10μF	±10%	5.5	4.0	6.0	5.0	3.15	16.0	2M1	2000
	RDEC71E226K3M1H03A	X7S	25	22μF	±10%	5.5	5.0	7.5	5.0	4.0	16.0	3M1	1500
	RDEC71E476MWM1H03A	X7S	25	47μF	±20%	5.5	7.5	10.0	5.0	4.0	16.0	WM1	1500
	RDER71H221K0M1H03A	X7R	50	220pF	±10%	4.0	3.5	6.0	5.0	2.5	16.0	0M1	2000
	RDER71H331K0M1H03A	X7R	50	330pF	±10%	4.0	3.5	6.0	5.0	2.5	16.0	0M1	2000
	RDER71H471K0M1H03A	X7R	50	470pF	±10%	4.0	3.5	6.0	5.0	2.5	16.0	0M1	2000
	RDER71H681K0M1H03A	X7R	50	680pF	±10%	4.0	3.5	6.0	5.0	2.5	16.0	0M1	2000
	RDER71H102K0M1H03A	X7R	50	1000pF	±10%	4.0	3.5	6.0	5.0	2.5	16.0	0M1	2000
	RDER71H152K0M1H03A	X7R	50	1500pF	±10%	4.0	3.5	6.0	5.0	2.5	16.0	0M1	2000
	RDER71H222K0M1H03A	X7R	50	2200pF	±10%	4.0	3.5	6.0	5.0	2.5	16.0	0M1	2000
	RDER71H332K0M1H03A	X7R	50	3300pF	±10%	4.0	3.5	6.0	5.0	2.5	16.0	0M1	2000
	RDER71H472K0M1H03A	X7R	50	4700pF	±10%	4.0	3.5	6.0	5.0	2.5	16.0	0M1	2000

• Inside Crimp Taping
(Lead Style: M*)

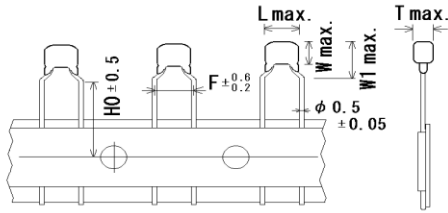

Unit : mm

Customer Part Number	Murata Part Number	T.C.	DC Rated Volt. (V)	Cap.	Cap. Tol.	Dimension (mm)						Dimension (LxW) Lead Style	Pack qty. (pcs)
						L	W	W1	F	T	H/HO		
	RDER71H682K0M1H03A	X7R	50	6800pF	±10%	4.0	3.5	6.0	5.0	2.5	16.0	0M1	2000
	RDER71H103K0M1H03A	X7R	50	10000pF	±10%	4.0	3.5	6.0	5.0	2.5	16.0	0M1	2000
	RDER71H153K0M1H03A	X7R	50	15000pF	±10%	4.0	3.5	6.0	5.0	2.5	16.0	0M1	2000
	RDER71H223K0M1H03A	X7R	50	22000pF	±10%	4.0	3.5	6.0	5.0	2.5	16.0	0M1	2000
	RDER71H333K0M1H03A	X7R	50	33000pF	±10%	4.0	3.5	6.0	5.0	2.5	16.0	0M1	2000
	RDER71H473K0M1H03A	X7R	50	47000pF	±10%	4.0	3.5	6.0	5.0	2.5	16.0	0M1	2000
	RDER71H683K0M1H03A	X7R	50	68000pF	±10%	4.0	3.5	6.0	5.0	2.5	16.0	0M1	2000
	RDER71H104K0M1H03A	X7R	50	0.10μF	±10%	4.0	3.5	6.0	5.0	2.5	16.0	0M1	2000
	RDER71H154K1M1H03A	X7R	50	0.15μF	±10%	4.5	3.5	5.0	5.0	3.15	16.0	1M1	2000
	RDER71H224K1M1H03A	X7R	50	0.22μF	±10%	4.5	3.5	5.0	5.0	3.15	16.0	1M1	2000
	RDER71H334K1M1H03A	X7R	50	0.33μF	±10%	4.5	3.5	5.0	5.0	3.15	16.0	1M1	2000
	RDER71H474K1M1H03A	X7R	50	0.47μF	±10%	4.5	3.5	5.0	5.0	3.15	16.0	1M1	2000
	RDER71H684K2M1H03A	X7R	50	0.68μF	±10%	5.5	4.0	6.0	5.0	3.15	16.0	2M1	2000
	RDEC71H105K1M1H03A	X7S	50	1.0μF	±10%	4.5	3.5	5.0	5.0	3.15	16.0	1M1	2000
	RDER71H105K2M1H03A	X7R	50	1.0μF	±10%	5.5	4.0	6.0	5.0	3.15	16.0	2M1	2000
	RDER71H155K2M1H03A	X7R	50	1.5μF	±10%	5.5	4.0	6.0	5.0	3.15	16.0	2M1	2000
	RDER71H225K2M1H03A	X7R	50	2.2μF	±10%	5.5	4.0	6.0	5.0	3.15	16.0	2M1	2000
	RDER71H335K3M1H03A	X7R	50	3.3μF	±10%	5.5	5.0	7.5	5.0	4.0	16.0	3M1	1500
	RDEC71H475K2M1H03A	X7S	50	4.7μF	±10%	5.5	4.0	6.0	5.0	3.15	16.0	2M1	2000
	RDEC71H106K3M1H03A	X7S	50	10μF	±10%	5.5	5.0	7.5	5.0	4.0	16.0	3M1	1500
	RDEC71H226MWM1H03A	X7S	50	22μF	±20%	5.5	7.5	10.0	5.0	4.0	16.0	WM1	1500
	RDER72A221K0M1H03A	X7R	100	220pF	±10%	4.0	3.5	6.0	5.0	2.5	16.0	0M1	2000
	RDER72A331K0M1H03A	X7R	100	330pF	±10%	4.0	3.5	6.0	5.0	2.5	16.0	0M1	2000
	RDER72A471K0M1H03A	X7R	100	470pF	±10%	4.0	3.5	6.0	5.0	2.5	16.0	0M1	2000
	RDER72A681K0M1H03A	X7R	100	680pF	±10%	4.0	3.5	6.0	5.0	2.5	16.0	0M1	2000
	RDER72A102K0M1H03A	X7R	100	1000pF	±10%	4.0	3.5	6.0	5.0	2.5	16.0	0M1	2000
	RDER72A152K0M1H03A	X7R	100	1500pF	±10%	4.0	3.5	6.0	5.0	2.5	16.0	0M1	2000
	RDER72A222K0M1H03A	X7R	100	2200pF	±10%	4.0	3.5	6.0	5.0	2.5	16.0	0M1	2000
	RDER72A332K0M1H03A	X7R	100	3300pF	±10%	4.0	3.5	6.0	5.0	2.5	16.0	0M1	2000
	RDER72A472K0M1H03A	X7R	100	4700pF	±10%	4.0	3.5	6.0	5.0	2.5	16.0	0M1	2000
	RDER72A682K0M1H03A	X7R	100	6800pF	±10%	4.0	3.5	6.0	5.0	2.5	16.0	0M1	2000
	RDER72A103K0M1H03A	X7R	100	10000pF	±10%	4.0	3.5	6.0	5.0	2.5	16.0	0M1	2000
	RDER72A153K0M1H03A	X7R	100	15000pF	±10%	4.0	3.5	6.0	5.0	2.5	16.0	0M1	2000
	RDER72A223K0M1H03A	X7R	100	22000pF	±10%	4.0	3.5	6.0	5.0	2.5	16.0	0M1	2000
	RDER72A333K1M1H03A	X7R	100	33000pF	±10%	4.5	3.5	5.0	5.0	3.15	16.0	1M1	2000
	RDER72A473K1M1H03A	X7R	100	47000pF	±10%	4.5	3.5	5.0	5.0	3.15	16.0	1M1	2000
	RDER72A683K1M1H03A	X7R	100	68000pF	±10%	4.5	3.5	5.0	5.0	3.15	16.0	1M1	2000
	RDER72A104K1M1H03A	X7R	100	0.10μF	±10%	4.5	3.5	5.0	5.0	3.15	16.0	1M1	2000
	RDER72A154K2M1H03A	X7R	100	0.15μF	±10%	5.5	4.0	6.0	5.0	3.15	16.0	2M1	2000
	RDER72A224K1M1H03A	X7R	100	0.22μF	±10%	4.5	3.5	5.0	5.0	3.15	16.0	1M1	2000

• Inside Crimp Taping
(Lead Style: M*)

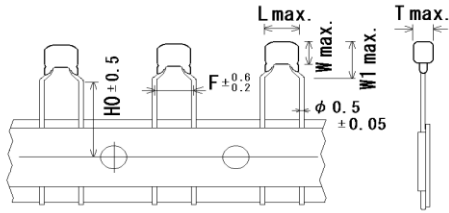

Unit : mm

Customer Part Number	Murata Part Number	T.C.	DC Rated Volt. (V)	Cap.	Cap. Tol.	Dimension (mm)						Dimension (LxW) Lead Style	Pack qty. (pcs)
						L	W	W1	F	T	H/H0		
	RDER72A334K1M1H03A	X7R	100	0.33μF	±10%	4.5	3.5	5.0	5.0	3.15	16.0	1M1	2000
	RDER72A474K1M1H03A	X7R	100	0.47μF	±10%	4.5	3.5	5.0	5.0	3.15	16.0	1M1	2000
	RDER72A684K2M1H03A	X7R	100	0.68μF	±10%	5.5	4.0	6.0	5.0	3.15	16.0	2M1	2000
	RDER72A105K2M1H03A	X7R	100	1.0μF	±10%	5.5	4.0	6.0	5.0	3.15	16.0	2M1	2000
	RDEC72A155K3M1H03A	X7S	100	1.5μF	±10%	5.5	5.0	7.5	5.0	4.0	16.0	3M1	1500
	RDEC72A225K3M1H03A	X7S	100	2.2μF	±10%	5.5	5.0	7.5	5.0	4.0	16.0	3M1	1500
	RDEC72A475MWM1H03A	X7S	100	4.7μF	±20%	5.5	7.5	10.0	5.0	4.0	16.0	WM1	1500

Reference only

5.SPECIFICATIONS AND TEST METHODS																
No.	Item		Specification	Test Method												
1	Appearance		No defects or abnormalities.	Visual inspection.												
2	Dimension and Marking		Within the specified dimensions and Marking	Visual inspection, Using Caliper.												
3	Dielectric Strength	Between Terminals	No defects or abnormalities.	The capacitor should not be damaged when voltage in Table is applied between the terminations for 1 to 5 seconds. (Charge/Discharge current \leq 50mA.) <table border="1" style="margin-left: auto; margin-right: auto;"><tr><th>Rated voltage</th><th>Test voltage</th></tr><tr><td>DC25V·DC50V</td><td rowspan="2">250% of the rated voltage</td></tr><tr><td>DC100V</td></tr></table>	Rated voltage	Test voltage	DC25V·DC50V	250% of the rated voltage	DC100V							
	Rated voltage	Test voltage														
DC25V·DC50V	250% of the rated voltage															
DC100V																
	Body Insulation		No defects or abnormalities.	The capacitor is placed in a container with metal balls of 1mm diameter so that each terminal, short-circuit, is kept approximately 2mm from the balls, and voltage in Table is impressed for 1 to 5 seconds between capacitor terminals and metal balls. (Charge/Discharge current \leq 50mA.) <table border="1" style="margin-left: auto; margin-right: auto;"><tr><th>Rated voltage</th><th>Test voltage</th></tr><tr><td>DC25V·DC50V</td><td rowspan="2">250% of the rated voltage</td></tr><tr><td>DC100V</td></tr></table>	Rated voltage	Test voltage	DC25V·DC50V	250% of the rated voltage	DC100V							
Rated voltage	Test voltage															
DC25V·DC50V	250% of the rated voltage															
DC100V																
4	Insulation Resistance (I.R.)	Between Terminals	10,000M Ω or 500M Ω · μ F min. (Whichever is smaller)	The insulation resistance should be measured with a DC voltage not exceeding the rated voltage at normal temperature and humidity and within 2 minutes of charging. (Charge/Discharge current \leq 50mA.)												
5	Capacitance		Within the specified tolerance.	The capacitance, D.F. should be measured at 25°C at the frequency and voltage shown in the table.												
6	Dissipation Factor (D.F.)		X7R : 0.025 max. X7S : 0.125 max.	<table border="1" style="margin-left: auto; margin-right: auto;"><tr><th>Nominal Cap.</th><th>Frequency</th><th>Voltage</th></tr><tr><td>C \leq 10μF</td><td>1\pm0.1kHz</td><td>AC1\pm0.2V (r.m.s.)</td></tr><tr><td>C > 10μF</td><td>120\pm24Hz</td><td>AC0.5\pm0.1V (r.m.s.)</td></tr></table>	Nominal Cap.	Frequency	Voltage	C \leq 10 μ F	1 \pm 0.1kHz	AC1 \pm 0.2V (r.m.s.)	C > 10 μ F	120 \pm 24Hz	AC0.5 \pm 0.1V (r.m.s.)			
Nominal Cap.	Frequency	Voltage														
C \leq 10 μ F	1 \pm 0.1kHz	AC1 \pm 0.2V (r.m.s.)														
C > 10 μ F	120 \pm 24Hz	AC0.5 \pm 0.1V (r.m.s.)														
7	Capacitance Temperature Characteristics		X7R : within \pm 15% X7S : within \pm 22%	The capacitance change should be measured after 5 min. at each specified temperature stage. The ranges of capacitance change compared with the 25°C value over the temperature ranges shown in the table should be within the specified ranges. <table border="1" style="margin-left: auto; margin-right: auto;"><tr><th>Step</th><th>Temperature(°C)</th></tr><tr><td>1</td><td>25\pm2</td></tr><tr><td>2</td><td>-55\pm3</td></tr><tr><td>3</td><td>25\pm2</td></tr><tr><td>4</td><td>125\pm3</td></tr><tr><td>5</td><td>25\pm2</td></tr></table> • Pretreatment Perform a heat treatment at 150+0/-10°C for one hour and then set at *room condition for 24 \pm 2 hours.	Step	Temperature(°C)	1	25 \pm 2	2	-55 \pm 3	3	25 \pm 2	4	125 \pm 3	5	25 \pm 2
Step	Temperature(°C)															
1	25 \pm 2															
2	-55 \pm 3															
3	25 \pm 2															
4	125 \pm 3															
5	25 \pm 2															
8	Terminal Strength	Tensile Strength	Termination not to be broken or loosened	As in the figure, fix the capacitor body, apply the force gradually to each lead in the radial direction of the capacitor until reaching 10N and then keep applied the force for 10 \pm 1 seconds. 												
		Bending Strength	Termination not to be broken or loosened	Each lead wire should be subjected to a force of 2.5N and then be bent 90° at the point of egress in one direction. Each wire is then returned to the original position and bent 90° in the opposite direction at the rate of one bend per 2 to 3 seconds.												
9	Vibration Resistance	Appearance	No defects or abnormalities.	The capacitor should be subjected to a simple harmonic motion having a total amplitude of 1.5mm, the frequency being varied uniformly between the approximate limits of 10Hz and 55Hz. The frequency range, from 10Hz to 55Hz and return to 10Hz, shall be traversed in approximately 1 minute. This motion shall be applied for a period of 2 hours in each 3 mutually perpendicular directions (total of 6 hours).												
		Capacitance	Within the specified tolerance.													
		D.F.	X7R : 0.025 max. X7S : 0.125 max.													

* "room condition" Temperature : 15 to 35°C, Relative humidity : 45 to 75%, Atmosphere pressure : 86 to 106kPa

Reference only

No.	Item	Specification	Test Method															
10	Solderability of Lead	Solder is deposited on unintermittently immersed portion in axial direction covering 3/4 or more in circumferential direction of lead wires.	The terminal of capacitor is dipped into a solution of ethanol (JIS K 8101) and rosin (JIS K 5902) (25% rosin in weight propotion). Immerse in solder solution for 2±0.5 seconds. In both cases the depth of dipping is up to about 1.5 to 2mm from the terminal body. Temp. of solder : 245±5°C Lead Free Solder (Sn-3.0Ag-0.5Cu) 235±5°C H60A or H63A Eutectic Solder															
11-1	Resistance to Soldering Heat (Non-Preheat)	Appearance	No defects or abnormalities.															
		Capacitance Change	X7R : Within ±7.5% X7S : Within ±10%															
		Dielectric Strength (Between terminals)	No defects.															
The lead wires should be immersed in the melted solder 1.5 to 2.0mm from the root of terminal at 260±5°C for 10±1 seconds. • Pretreatment Capacitor should be stored at 150+0/-10°C for one hour, then place at *room condition for 24±2 hours before initial measurement. • Post-treatment Capacitor should be stored for 24±2 hours at *room condition.																		
11-2	Resistance to Soldering Heat (On-Preheat)	Appearance	No defects or abnormalities.															
		Capacitance Change	X7R : Within ±7.5% X7S : Within ±10%															
		Dielectric Strength (Between terminals)	No defects.															
First the capacitor should be stored at 120+0/-5°C for 60+0/-5 seconds. Then, the lead wires should be immersed in the melted solder 1.5 to 2.0mm from the root of terminal at 260±5°C for 7.5+0/-1 seconds. • Pretreatment Capacitor should be stored at 150+0/-10°C for one hour, then place at *room condition for 24±2 hours before initial measurement. • Post-treatment Capacitor should be stored for 24±2 hours at *room condition.																		
11-3	Resistance to Soldering Heat (soldering iron method)	Appearance	No defects or abnormalities.															
		Capacitance Change	X7R : Within ±7.5% X7S : Within ±10%															
		Dielectric Strength (Between terminals)	No defects.															
Test condition Temperature of iron-tip : 350±10°C Soldering time : 3.5±0.5 seconds Soldering position Straight Lead : 1.5 to 2.0mm from the root of terminal. Crimp Lead : 1.5 to 2.0mm from the end of bend. • Pretreatment Capacitor should be stored at 150+0/-10°C for one hour, then place at *room condition for 24±2 hours before initial measurement. • Post-treatment Capacitor should be stored for 24±2 hours at *room condition.																		
12	Temperature Cycle	Appearance	No defects or abnormalities.															
		Capacitance Change	X7R, X7S : Within±12.5%															
		D.F.	X7R : 0.05 max. X7S : 0.2 max.															
		I.R.	1,000MΩ or 50MΩ·μF min. (Whichever is smaller)															
		Dielectric Strength (Between Terminals)	No defects or abnormalities.															
Repeat 5 cycles according to the 4 heat treatments listed in the following table. Set at *room condition for 24±2 hours, then measure.																		
<table border="1" style="margin-left: auto; margin-right: auto;"> <thead> <tr> <th>Step</th> <th>1</th> <th>2</th> <th>3</th> <th>4</th> </tr> </thead> <tbody> <tr> <td>Temp. (°C)</td> <td>Min. Operating Temp. ±3</td> <td>Room Temp.</td> <td>Max. Operating Temp. ±3</td> <td>Room Temp.</td> </tr> <tr> <td>Time (min.)</td> <td>30±3</td> <td>3 max.</td> <td>30±3</td> <td>3 max.</td> </tr> </tbody> </table>				Step	1	2	3	4	Temp. (°C)	Min. Operating Temp. ±3	Room Temp.	Max. Operating Temp. ±3	Room Temp.	Time (min.)	30±3	3 max.	30±3	3 max.
Step	1	2	3	4														
Temp. (°C)	Min. Operating Temp. ±3	Room Temp.	Max. Operating Temp. ±3	Room Temp.														
Time (min.)	30±3	3 max.	30±3	3 max.														
• Pretreatment Perform a heat treatment at 150+0/-10°C for one hour and then set at *room condition for 24±2 hours.																		
13	Humidity (Steady State)	Appearance	No defects or abnormalities.															
		Capacitance Change	X7R, X7S : Within ±15%															
		D.F.	X7R : 0.05 max. X7S : 0.2 max.															
		I.R.	1,000MΩ or 50MΩ·μF min. (Whichever is smaller)															
Set the capacitor at 40±2°C and relative humidity 90 to 95% for 500+24/-0 hours. Remove and set for 24±2 hours at *room condition, then measure. • Pretreatment Perform a heat treatment at 150+0/-10°C for one hour and then set at *room condition for 24±2 hours.																		

* "room condition" Temperature : 15 to 35°C, Relative humidity : 45 to 75%, Atmosphere pressure : 86 to 106kPa

Reference only

No.	Item	Specification	Test Method
14	Humidity Load	Appearance	No defects or abnormalities.
		Capacitance Change	X7R, X7S : Within±15%
		D.F.	X7R : 0.05 max. X7S : 0.2 max.
		I.R.	500MΩ or 25MΩ·μF min. (Whichever is smaller)
			Apply the rated voltage at 40±2°C and relative humidity of 90 to 95% for 500+24/-0 hours. Remove and set for 24±2 hours at *room condition, then measure. (Charge/Discharge current ≤ 50mA.) • Pretreatment Perform a heat treatment at 150+0/-10°C for one hour and then set at *room condition for 24±2 hours.
15	High Temperature Load	Appearance	No defects or abnormalities.
		Capacitance Change	X7R, X7S : Within±15%
		D.F.	X7R : 0.05 max. X7S : 0.2 max.
		I.R.	1,000MΩ or 50 MΩ·μF min. (Whichever is smaller)
			Apply 150% of the rated voltage at the maximum operating temperature ±3°C for 1000+48/-0 hours. Remove and set for 24±2 hours at *room condition, then measure. (Charge/Discharge current ≤ 50mA.) • Pretreatment Apply test voltage for one hour at test temperature. Remove and set at *room condition for 24±2 hours.
16	Solvent Resistance	Appearance	No defects or abnormalities.
		Marking	Legible
			The capacitor should be fully immersed, unagitated, in reagent at 20 to 25°C for 30±5 seconds and then remove gently. Marking on the surface of the capacitor shall immediately be visually examined. Reagent : Isopropyl alcohol

* "room condition" Temperature : 15 to 35°C, Relative humidity : 45 to 75%, Atmosphere pressure : 86 to 106kPa

6. Packing specification

- Bulk type (Packing style code : B)

The size of packing case and packing way

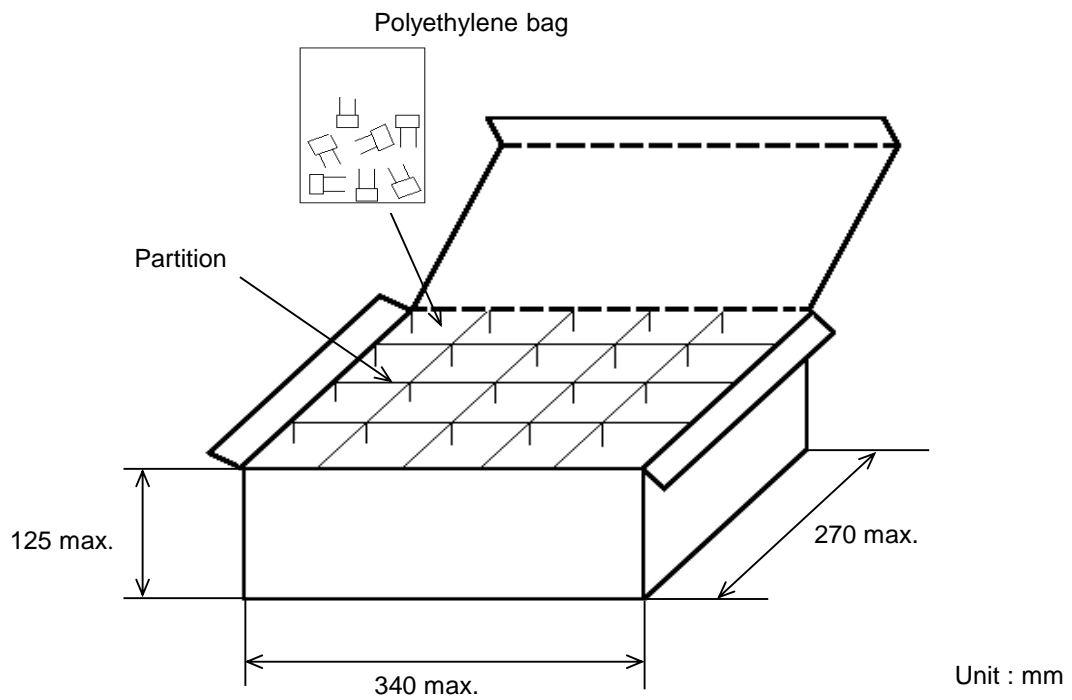

The number of packing = ^{*1} Packing quantity × ^{*2} n

*1 : Please refer to [Part number list].

*2 : Standard n = 20 (bag)

Note)

The outer package and the number of outer packing be changed by the order getting amount.

• Ammo pack taping type (Packing style code : A)

A crease is made every 25 pitches, and the tape with capacitors is packed zigzag into a case. When body of the capacitor is piled on other body under it.

The size of packing case and packing way

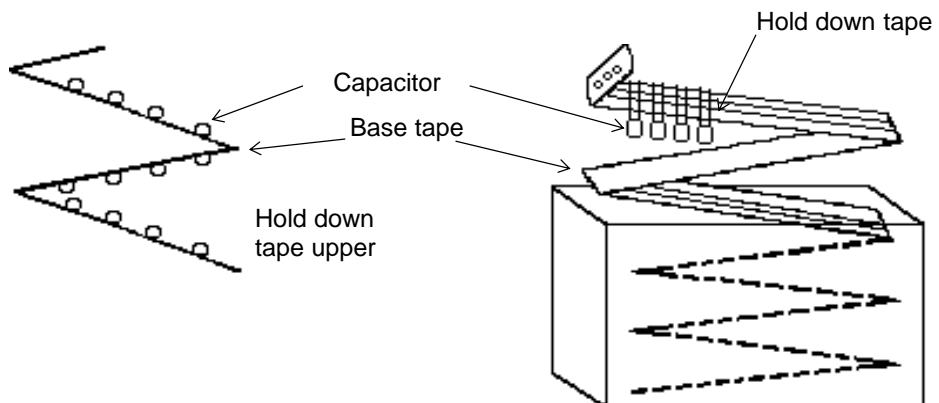
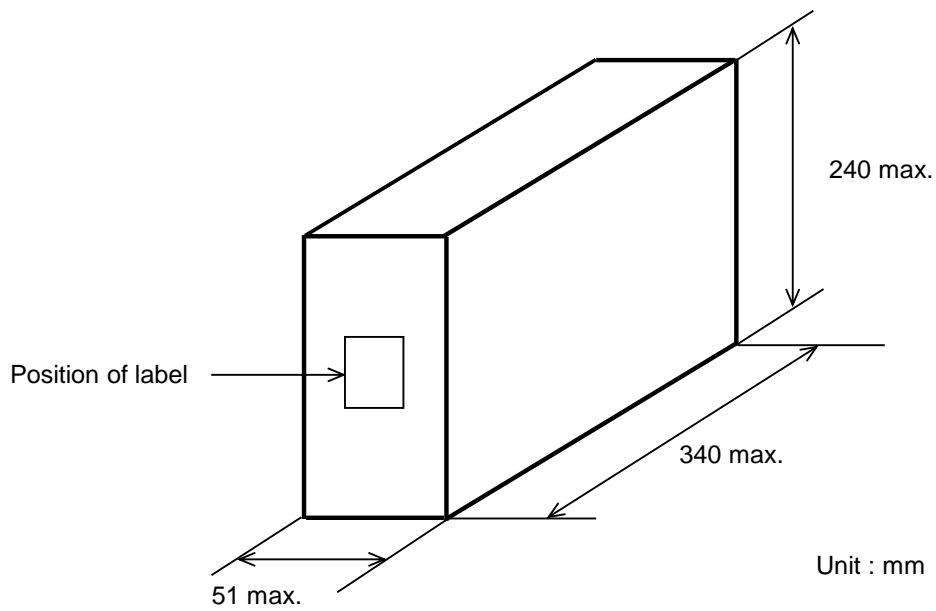

7. Taping specification

7-1. Dimension of capacitors on tape

Inside crimp taping type < Lead Style : M1 >

Pitch of component 12.7mm / Lead spacing 5.0mm

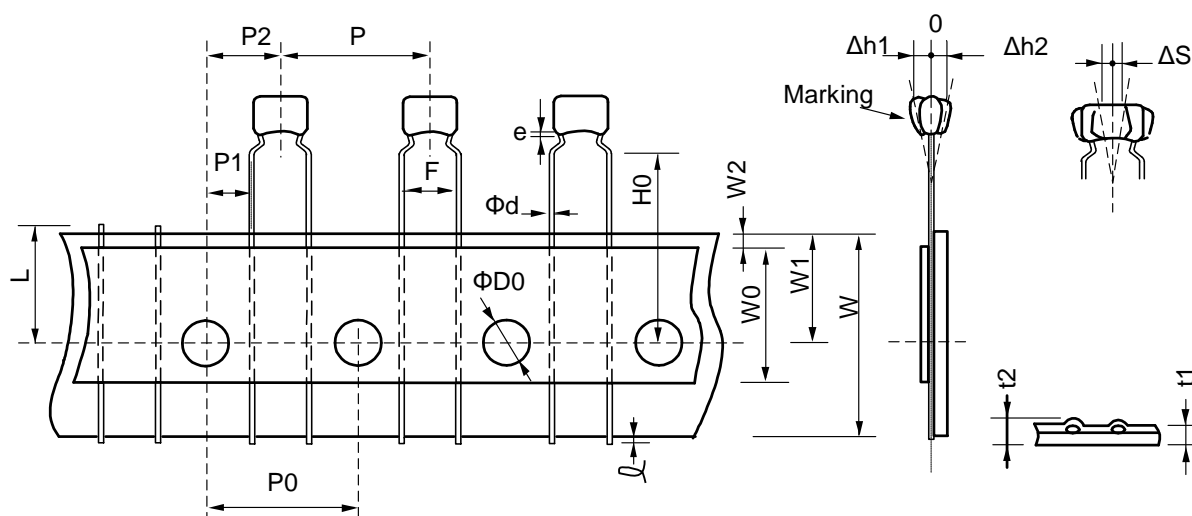

Unit : mm

Item	Code	Dimensions	Remarks
Pitch of component	P	12.7+/-1.0	
Pitch of sprocket hole	P0	12.7+/-0.2	
Lead spacing	F	5.0+0.6/-0.2	
Length from hole center to component center	P2	6.35+/-1.3	Deviation of progress direction
Length from hole center to lead	P1	3.85+/-0.7	
Deviation along tape, left or right defect	ΔS	0+/-2.0	They include deviation by lead bend
Carrier tape width	W	18.0+/-0.5	
Position of sprocket hole	W1	9.0+0/-0.5	Deviation of tape width direction
Lead distance between reference and bottom plane	H0	16.0+/-0.5	
Protrusion length	ℓ	0.5 max.	
Diameter of sprocket hole	ΦD0	4.0+/-0.1	
Lead diameter	Φd	0.5+/-0.05	
Total tape thickness	t1	0.6+/-0.3	They include hold down tape thickness
Total thickness of tape and lead wire	t2	1.5 max.	
Deviation across tape	Δh1	2.0 max. (Dimension code : W)	
	Δh2	1.0 max. (except as above)	
Portion to cut in case of defect	L	11.0+0/-1.0	
Hold down tape width	W0	9.5 min.	
Hold down tape position	W2	1.5+/-1.5	
Coating extension on lead	e	Up to the end of crimp	

Outside crimp tapping type < Lead Style : S1 >
Pitch of component 12.7mm / Lead spacing 2.5mm

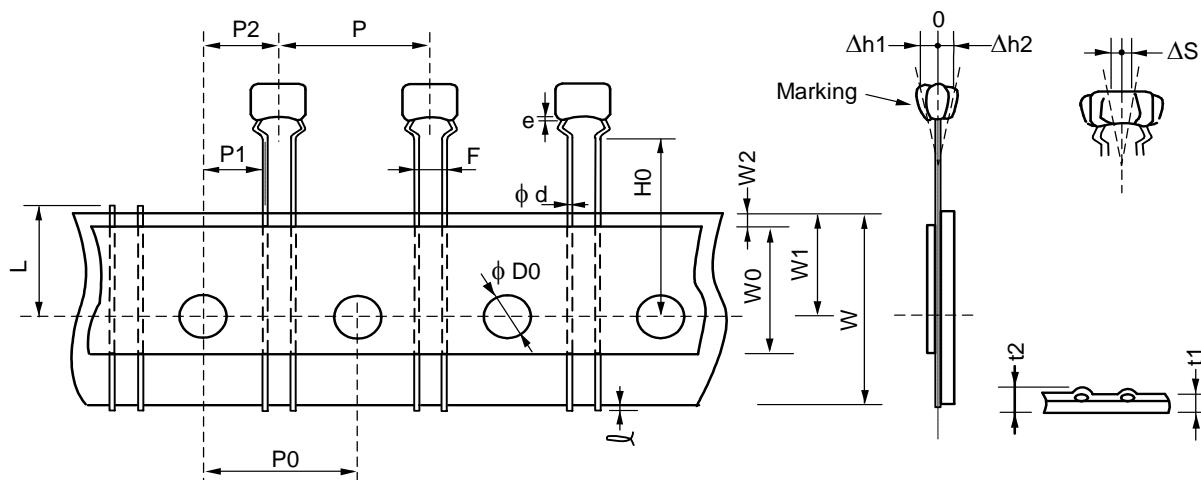

Unit : mm

Item	Code	Dimensions	Remarks
Pitch of component	P	12.7+/-1.0	
Pitch of sprocket hole	P0	12.7+/-0.2	
Lead spacing	F	2.5+0.4/-0.2	
Length from hole center to component center	P2	6.35+/-1.3	Deviation of progress direction
Length from hole center to lead	P1	5.1+/-0.7	
Deviation along tape, left or right defect	ΔS	0+/-2.0	They include deviation by lead bend
Carrier tape width	W	18.0+/-0.5	
Position of sprocket hole	W1	9.0+0/-0.5	Deviation of tape width direction
Lead distance between reference and bottom plane	H0	16.0+/-0.5	
Protrusion length	ℓ	0.5 max.	
Diameter of sprocket hole	ΦD0	4.0+/-0.1	
Lead diameter	Φd	0.5+/-0.05	
Total tape thickness	t1	0.6+/-0.3	They include hold down tape thickness
Total thickness of tape and lead wire	t2	1.5 max.	
Deviation across tape	Δh1	1.0 max.	
	Δh2		
Portion to cut in case of defect	L	11.0+0/-1.0	
Hold down tape width	W0	9.5 min.	
Hold down tape position	W2	1.5+/-1.5	
Coating extension on lead	e	Up to the end of crimp	

7-2. Splicing way of tape

1) Adhesive force of tape is over 3N at test condition as below.

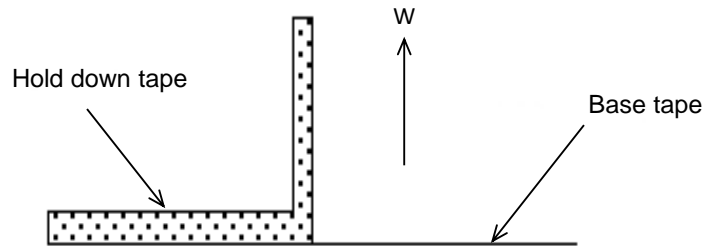

2) Splicing of tape

a) When base tape is spliced

- Base tape shall be spliced by cellophane tape.
(Total tape thickness shall be less than 1.05mm.)

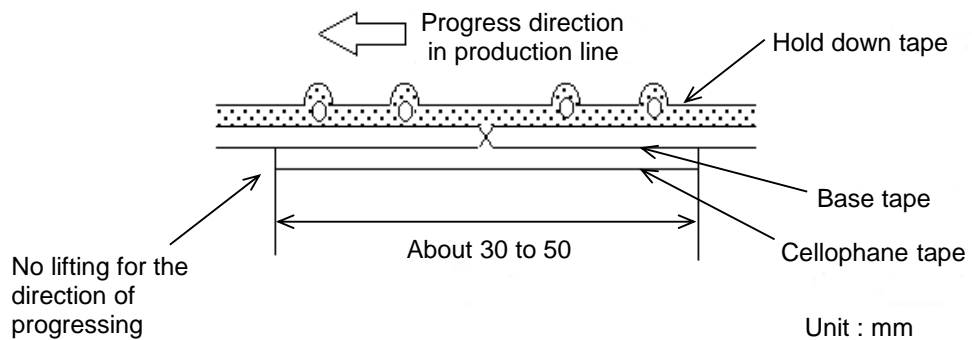

b) When hold down tape is spliced

- Hold down tape shall be spliced with overlapping.
(Total tape thickness shall be less than 1.05mm.)

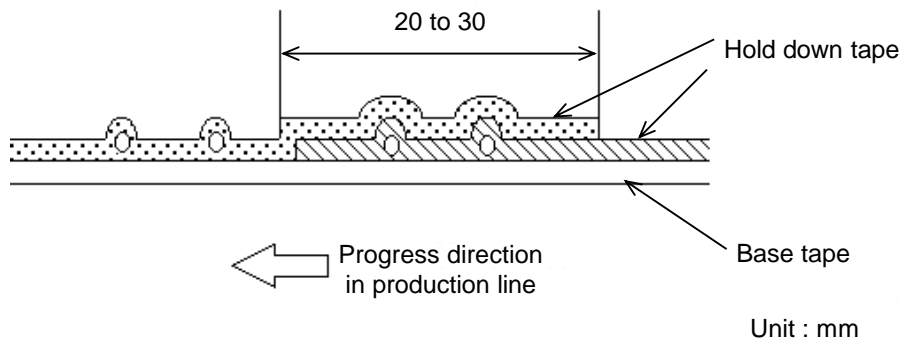

c) When both tape are spliced

- Base tape and hold down tape shall be spliced with splicing tape.