

C0603C0G1H680J030BA

TDK Item Description : C0603C0G1H680JT****



Application & Main Feature

Commercial Grade (General (Up to 50V))

Series

C0603 [EIA CC0201]

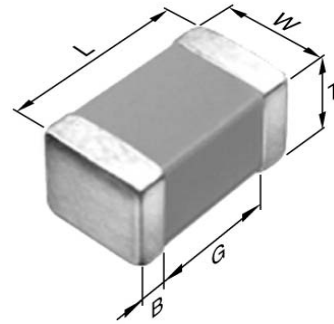

Dimensions

L 0.60mm +/-0.03mm
 W 0.30mm +/-0.03mm
 T 0.30mm +/-0.03mm
 B 0.10mm Min.
 G 0.20mm Min.

Temperature Characteristic

C0G (-55 to 125 degC 0+/-30ppm/degC)

Rated Voltage

1H (50Vdc)

Capacitance

68pF

Capacitance Tolerance

J (+/-5%)

Q Factor

1000 Min.

Insulation Resistance

10Gohm Min.

AEC-Q200

Not Applicable

|Z|, ESR vs. Freq. Characteristics

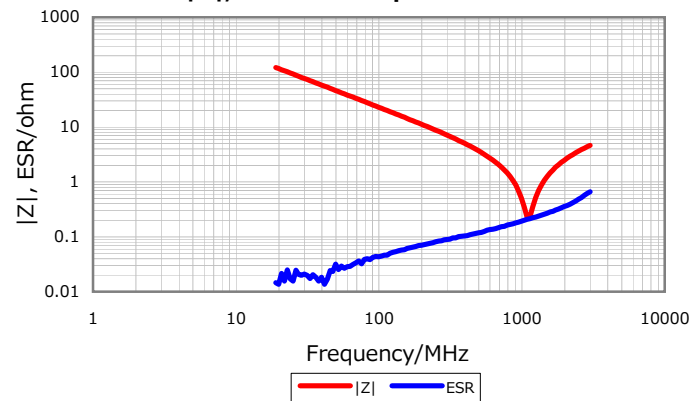

DC Bias Characteristic



Cap. vs. Freq. Characteristic

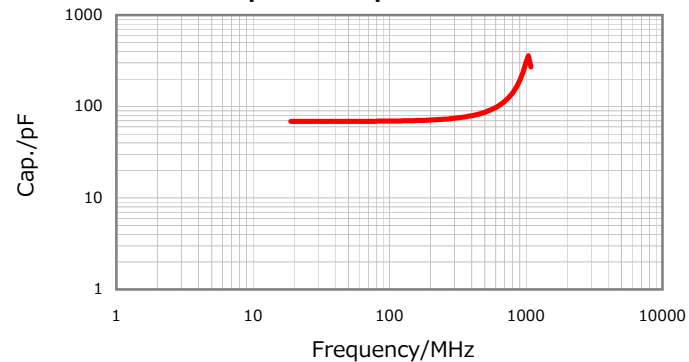

Temperature Characteristics



Characterization Sheet (Multilayer Ceramic Chip Capacitors)



All specifications are subject to change without notice.

January 2, 2016