

CGA5C2NP01H682J060AA

TDK Item Description : CGA5C2NP01H682JT***



Equivalent C3216NP01H682J for Automotive

Application & Main Feature

Automotive Grade (High Temperature Application)

Series

CGA5(3216) [EIA CC1206]

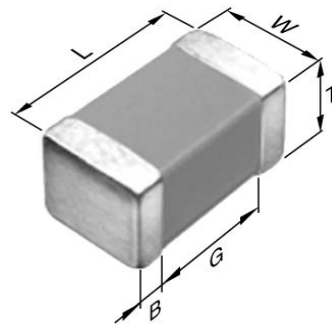

Dimensions

L 3.20mm +/-0.2mm
 W 1.60mm +/-0.2mm
 T 0.60mm +/-0.15mm
 B 0.20mm Min.
 G 1.00mm Min.

Temperature Characteristic

NP0 (-55 to 150 degC 0+/-30ppm/degC)

Rated Voltage

1H (50Vdc)

Capacitance

6.8nF

Capacitance Tolerance

J (+/-5%)

Q Factor

1000 Min.

Insulation Resistance

10Gohm Min.

AEC-Q200

Yes

|Z|, ESR vs. Freq. Characteristics

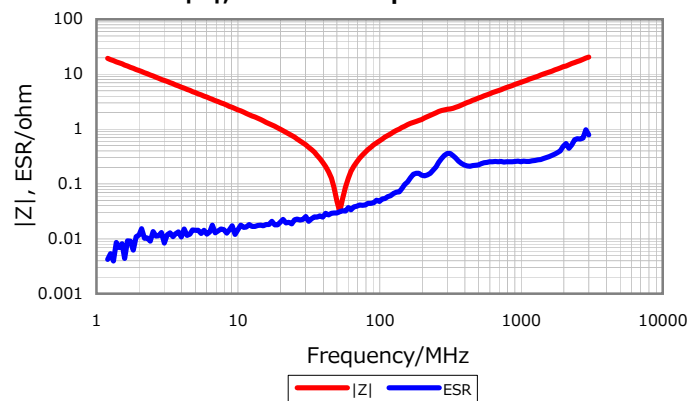

DC Bias Characteristic



Cap. vs. Freq. Characteristic

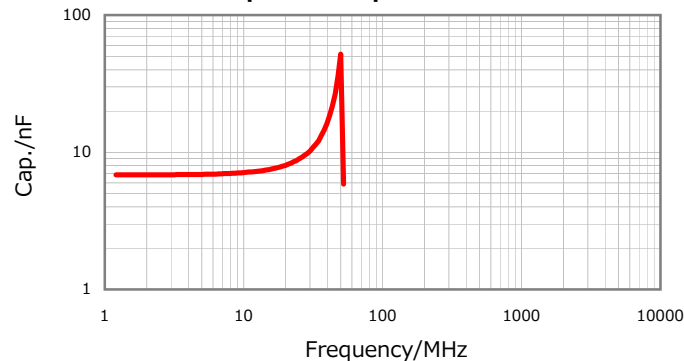

Temperature Characteristics

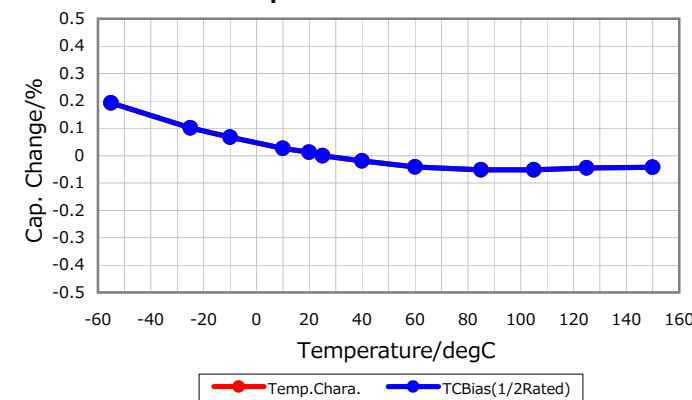

Characterization Sheet (Multilayer Ceramic Chip Capacitors)



All specifications are subject to change without notice.

January 4, 2016